

# dnd



22-  
23

Un catalogo di maniglie  
di alta qualità sviluppate  
grazie a ricerca, creatività,  
esperienza: valori che  
da sempre accompagnano  
Dnd e le sue collezioni.

A catalogue of high quality  
handles developed thanks  
to research, creativity and  
experience: values  
that have always  
accompanied Dnd and its  
collections.



**dnd**

**handles  
with care**

**22-  
23**



Maniglie che sono frutto di **cura, attenzione, passione.**

































Dnd mette la sua sapienza produttiva al servizio della migliore creatività, coinvolgendo nello sviluppo delle collezioni **progettisti di valore** per focalizzare l'attenzione verso il mondo del design, arricchire la gamma dei prodotti e soddisfare al meglio la progettazione degli interni contemporanei.

























*Handles that are the result of **care, attention and passion.***

*Dnd puts its manufacturing expertise at the service of the most brilliant creativity, collaborating with **outstanding designers** to develop collections that shine a light on the world of design, enrich its range of products and fully satisfy the needs of contemporary interior design.*

# indice / index

## design

aretè		214	eleonora <small>NEW</small>		078
aretè 02		218	eleonora 02 <small>NEW</small>		082
aretè L		220	esa		262
aretè L 02		224	esa due		258
art		282	fluke		238
blend		136	fluò		306
blip		288	fold		270
boole		160	fold 02		272
C-1918		200	freely <small>NEW</small>		086
change B 02		232	ginevra		198
chop		268	ginkgo		176
cloe		226	ginkgo biloba		180
cloe 02		230	go		308
dolce		286	havana		300
drop		130	holly		264
DUE		110	(IN)finito		092
edra 02		234	iki		170

intake		204	pod <sup>NEW</sup>		064
isabella		188	project		294
joy		274	project 02		296
joy 02		276	project zancata		298
levante		124	quattro 02 Z		314
linear		284	S40		315
link		314	S50		315
luce		248	S60		315
luce 02		252	safety		166
luce P <sup>NEW</sup>		242	san <sup>NEW</sup>		070
luce P 02 <sup>NEW</sup>		246	san 02 <sup>NEW</sup>		074
lucrezia		192	short		254
lucrezia 02		196	sike		292
luxury		208	sike 02		292
luxury 02		212	sochic		278
madeleine		154	sochic 02		278
minima		266	sochic L		280
mix		310	sochic L 02		280
nova		314	stick 02		312

---

















# design

timeless		184
tipo		314
twist		290
twist 02		290
vita		302
vita 02		304
viva!		142
zeppelin		148



---

# classic

airone		340
appia		338
ardea		328
beauty		340
beverly		332
bruxelles		340
cassia		330
classic		326
daniela		341
daniela p.		341
fedora		322
fiore		320
fiorenza		318
lady		336
latina		334
lirica		324
lorena		341

---



Combinazioni  
particolari  
*Combinations* 342

---

Maniglie per finestre  
*Windows handles* 348

---

Maniglioni  
*Pull handles*

aretè 370  
aretè L 371  
art 380  
beverly 390  
beverly corto 391  
C-1918 372  
C-1918 zancato 373  
cloe 385  
daniela 392  
domus 384  
eleonora  364  
fluke 383  
ginkgo 366  
ginkgo biloba 367  
go 381  
(IN)finito  362  
intake 382  
latina 393  
linear 376

logo	374
logo B	375
luce	389
lucrezia	368
luxury	369
only	388
pod 	360
project	378
project spostato	379
solid square	387
tube round	386
zeppelin 	361

---

Maniglioni per  
alzante scorrevole  
*Pull handles for  
lift sliding system*

edra	396
edra corto	397
edra 02	398
edra 02 corto	399
liter	404
luce	400
luce 02	401
slide	402
slide corto	403
Placche incasso <i>Sliding door handles</i>	405

---

Pomoli  
*Knobs*

easy	410
fiorenza	413
lucrezia	408
lucrezia 02	408
lucrezia 03	409
ovale centrale	413
project	411
quadro	412
ring	409
rondò	410
sfera	412
timeless	411
Pomolini per mobili <i>Furniture knobs</i>	414
Accessori per mobili <i>Furniture accessories</i>	415

---

Maniglie per porte scorrevoli  
*Sliding door handles*

ginkgo tonda	418
ginkgo quadra	420
noxia	431
quadra	426
rettangolare	430
ring	422
rondò	424
tonda	428
Serrature <i>Locks</i>	432

---

## Articoli vari

### *Other complements*

Nottolini	
<i>Turn &amp; releases</i>	436
Bocchette	
<i>Escutcheons</i>	452
Fermaporta	
<i>Door stop</i>	458
Chiavi	
<i>Keys</i>	459
Cerniere	
<i>Hinges</i>	460
Placche	
<i>Plates</i>	462

---

## Sistemi per porte e finestre

<i>Door and window systems</i>	028
--------------------------------	-----

---

## Legenda sistemi

<i>Systems summary</i>	040
------------------------	-----

---

## Finiture

<i>Finishes</i>	044
-----------------	-----

---

## Legenda finiture

<i>Finishes summary</i>	042
-------------------------	-----

# azienda / company

Oggi Dnd è un punto di riferimento internazionale per la produzione di **maniglie che guardano alla qualità e al progetto.**

La storia di Dnd nasce oltre cinquant'anni fa, nel 1968, dall'**antica e spiccata dedizione artigianale e industriale** diffusa nella Val Sabbia, in provincia di Brescia: un territorio con un sapere materiale centenario, soprattutto a vocazione siderurgica. Nel tempo, l'azienda si è evoluta e si è concentrata sullo sviluppo e sull'incremento della produzione, rinnovando i processi produttivi e **specializzandosi nella lavorazione e nella rifinitura dei diversi metalli** destinati alla produzione delle maniglie, come la zama e l'alluminio, oltre naturalmente all'ottone.

*Today, Dnd is an international reference point for the production of **handles with a focus on high quality and good design.***

*The history of Dnd began more than fifty years ago, in 1968, arising from the **ancient and strong craft and industrial dedication** which has its strong roots in Val Sabbia, in the province of Brescia. This is an area with centuries of material knowledge, especially in the steel industry. The firm has evolved over time, concentrating on production growth, updating manufacturing processes and **specializing in the use and finishing of various metals** for the production of handles, including zamak and aluminium as well as brass.*



Dnd è diretta da Vilma Martinelli insieme ai figli Pietro e Simona: immaginano Dnd come **una fucina di idee in grado di coniugare la lunga esperienza produttiva** acquisita con la **creatività degli architetti e dei designer** di valore che vengono puntualmente coinvolti nel disegno dei prodotti.

Dal 2017, Dnd ha scelto **Giulio Iacchetti come direttore artistico**: un designer industriale di grande talento, impegnato nello sviluppo del catalogo, nella strategia, nella selezione dei progettisti e dei consulenti da coinvolgere.

*Dnd is managed by Vilma Martinelli together with her son Pietro and daughter Simona: they see the company as **a forge of ideas able to combine the long manufacturing experience** gathered over time with the **creativity of valuable architects and designers** who are duly involved in the design of the products.*

*Since 2017, Dnd appointed **Giulio Iacchetti as its art director**: a very talented industrial designer, involved in the development of the catalogue, the strategy, the selection of designers and consultants to be involved.*







**Azienda con  
certificazione  
sistema di qualità  
UNI EN ISO 9001**

- Progettazione ottimizzata
- Costante formazione delle risorse umane
- Ambiente di lavoro controllato
- Produzione tecnologicamente avanzata
- Monitoraggio instancabile

***A company with  
UNI EN ISO 9001  
quality system  
certification***

- *Optimized design*
- *Constant training of human resources*
- *Controlled working environment*
- *Technologically advanced production*
- *Continuous monitoring*



# responsabilità / *responsibility*



Dnd è felice di promuovere ogni giorno azioni e processi attenti all'ambiente e si impegna in diversi progetti legati alla sostenibilità al fine di migliorare la salute del luogo di lavoro e sviluppare un senso di responsabilità, come strategia e come scelta.

*Dnd is happy to promote environmentally friendly actions and processes every day, and is involved in a number of sustainability-related projects to improve health in the workplace and develop a sense of responsibility, as a strategy and as a choice.*



## WeForest

Compensiamo il consumo di carburante dei nostri automezzi e delle nostre autovetture con il rimboscamento nella regione del Katanino, in Zambia.

*We offset the fuel consumption of our vehicles and cars with reforestation in the Katanino region of Zambia.*



## Stampa a freddo / Cold printing

Abbiamo sostituito il nostro sistema di stampa con i prodotti Epson Inkjet per la stampa a freddo, che riducono i costi e i consumi energetici fino all'83% rispetto alle stampanti laser.

*We have replaced our printing system with Epson Inkjet cold printing products, which reduce costs and energy consumption by up to 83% compared to laser printers.*



## 100% GREEN A2A

Certificazione della Camera di Commercio di Brescia che garantisce l'impiego di energia derivante da fonti 100% rinnovabili.

*Certification from the Brescia Chamber of Commerce guaranteeing the use of energy from 100% renewable sources.*



## FSC®

Utilizziamo il minor quantitativo di carta possibile: abbiamo ridotto del 50% il consumo e scegliamo per i nostri listini e cataloghi solo carta certificata FSC®

*We use as little paper as possible: we have reduced our paper consumption by 50% and choose only FSC®-certified paper for our price lists and catalogues.*

# made in italy



Produrre maniglie di qualità e **completamente Made in Italy da oltre cinquant'anni**: una scelta strategica di lunga data che si fonda sui valori della cultura aziendale italiana e sul profondo legame che Dnd ha nei confronti del suo territorio e del suo distretto, la Valle Sabbia.

Dnd è Made in Italy con l'orgoglio di realizzare prodotti grazie al **sapere**, alla **ricerca**, allo **stile** e alla **cura** che oggetti di piccole dimensioni – come le maniglie – richiedono.

L'eccellenza e il valore del design italiano si fondano da sempre sullo sviluppare, lavorare, rifinire e collaudare in Italia: passaggi importanti a tutela di prodotti di qualità.

Dalla creatività ai materiali, dal disegno al progetto, dalla produzione alle finiture, maniglie che sono da sempre fatte in Italia e fatte di Italia per entrare nelle case più belle e accoglienti, per caratterizzare **progetti architettonici di pregio** e per soddisfare al meglio le personalizzazioni del mondo contract, in Italia e nel mondo.

*To produce high-quality handles, **completely Made in Italy, for over fifty years**: a long-term strategy based on the values of an Italian corporate culture and the deep bond between Dnd and Valle Sabbia, its district and its territory.*

*Dnd is Made in Italy with pride, to create products thanks to **know-how, research, style, and all the care** that has to go into objects of small size such as handles. The excellence and value of Italian design are constants in the development, workmanship and testing, all done in Italy: important phases to guarantee products of the highest quality.*

*From creativity to materials, the drawing to the project, the production to the finishing, handles that are always made in Italy and made of Italy, to enter the most beautiful, appealing homes, to enhance **outstanding works of architecture**, to offer an optimal response to needs of customization in the contract sector, in Italy and the world.*



# L'architettura per le mani *Handling architecture*

**Coinvolgere degli architetti**, che non si erano mai – o poco – occupati di design, per progettare una maniglia: questa la sfida immaginata da Dnd insieme a Giulio Iacchetti, proposta a **cinque studi** di origine italiana e molto attivi a livello internazionale che con entusiasmo hanno risposto all'appello. **Stefano Boeri Architetti, Alfonso Femia, Maurizio Varratta, Cino Zucchi** e **967arch** hanno progettato cinque maniglie, presentate durante la Design Week milanese e poi entrate con successo in catalogo. *L'architettura per le mani* è il titolo del progetto: una riflessione intorno all'oggetto maniglia, che necessita sempre di essere fissato nello spazio con nuovi canoni estetici e nuovi equilibri formali.

**Involving architects** who had never – or seldom – focused on product design, inviting them to create a handle: this was the challenge formulated by Dnd together with Giulio Iacchetti and suggested to five architecture firms with an Italian background very active on an international level, who enthusiastically responded to the call. **Stefano Boeri Architetti, Alfonso Femia, Maurizio Varratta, Cino Zucchi** and **967arch** designed five handles, which were presented during the Milan Design Week and then successfully entered in the catalogue. *Handling architecture* is the title of the project: a reflection around the handle object, which always needs to be fixed in space with new aesthetic canons and new formal balances.





## Design focus

Per disegnare maniglie in cui siano evidenti la ricerca e la qualità del progetto, Dnd si impegna a collaborare con **progettisti di talento** su scala internazionale. Con continuità e attenzione, insieme al direttore artistico, vengono selezionati i designer a cui affidare i progetti destinati ad arricchire le collezioni Dnd: voci dal **miglior mondo del progetto**, vicine all'abitare contemporaneo.

*In order to design handles in which research and design quality are highlighted, Dnd is committed to working with **talented designers** on an international scale. With continuity and care, together with the artistic director, designers are selected to be entrusted with projects destined to enrich the Dnd collections: voices from **the best world of design**, close to contemporary living.*

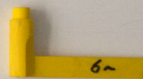
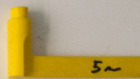
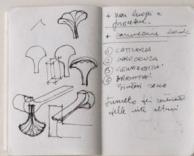
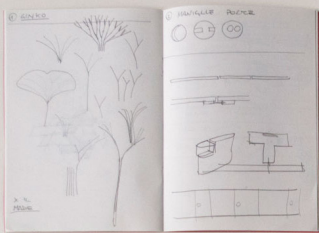



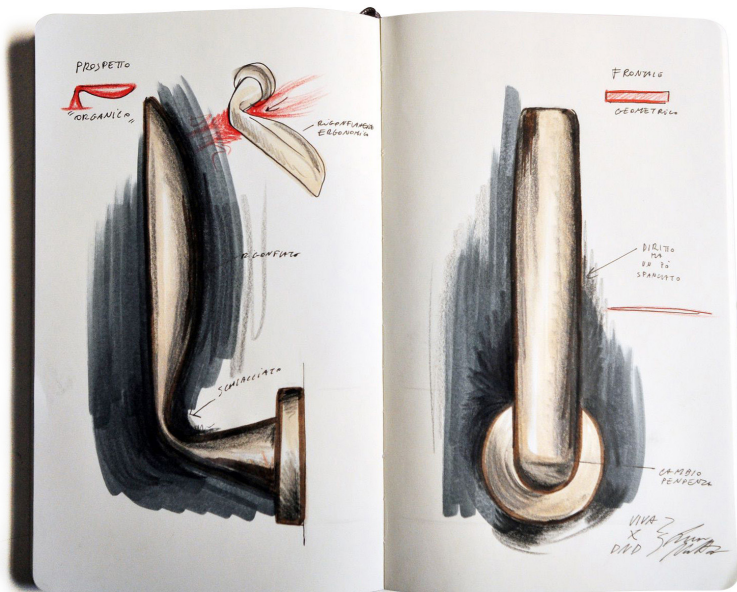

I prodotti sviluppati dai designer che collaborano con la fucina creativa Dnd sono sempre più numerosi: un **processo di crescita che è strategico e produttivo**.

I progettisti coinvolti sono sia giovani sia di lunga e riconosciuta esperienza: con linguaggi diversi, i designer si misurano con interesse e coinvolgimento con lo studio e lo sviluppo delle maniglie. La volontà di Dnd è di allargare il suo sguardo e accogliere idee e sfide sempre nuove.

*The products developed by the designers who collaborate with the Dnd creative forge are increasingly numerous: a **growth process that is both strategic and productive**.*

*The designers involved are both young and with long and recognised experience: with different languages, the designers challenge themselves with interest and involvement in the study and development of the handles. Dnd wants to broaden its horizons and welcome new ideas and challenges.*

Dnd ha scelto di lavorare con la **qualità, valore intrinseco del buon design.**

Una qualità diffusa e applicata a tutti i processi e le espressioni dell'azienda: dall'immagine coordinata al disegno delle maniglie, dalla produzione alla comunicazione e all'esposizione dei prodotti stessi.

Questa scelta è un fatto culturale e un percorso, in evoluzione e in crescita, che ha portato all'azienda **riconoscimenti importanti dal mondo del progetto:** un mondo di riferimento con cui Dnd si misura con impegno e positiva dinamicità.

*Dnd has chosen to work with **quality, an intrinsic value of good design.** A quality that is widespread and applied to all the processes and expressions of the company: from corporate identity to the design of the handles, from production to communication and the display of the products.*

*This choice is a cultural factor and a path, evolving and growing, which has brought the company **important recognition from the world of design:** a world of reference with which Dnd challenge itself with commitment and positive dynamism.*



**Good Design Awards 2017**

Ginkgo  
Design by Giulio Iacchetti



**Selected for ADI DESIGN 2019**

(IN) finito  
Design by Alfonso Femia



Dnd @ supersalone, Salone del Mobile.Milano, Rho Fiera - Milano (2021)

# progettisti / *designers*



Stefano Boeri  
Architetti



Achille  
Castiglioni



Gianfranco  
Cavaglia



Alfonso  
Femia



Odo  
Fioravanti



Jaime  
Hayon



Holscher  
Design



Studio  
Hot Lab



Giulio  
Iacchetti



Enrico  
Martini



Andrea  
Morgante



Luca  
Nichetto



Nicola  
Novelletto



Mario  
Padiglione



Marco  
Pisati



Karim  
Rashid



**Mauro  
Ronchi**



**Sandro  
Santantonio**



**Mario  
Scairato**



**Didier  
Schweizer**



**Inga  
Sempé**



**Alessandro  
Stabile**



**Philippe  
Tabet**



**Maurizio  
Varratta**



**Cino  
Zucchi**



**967arch**

– Door and

Sistemi  
per porte  
e finestre

window systems



minimal,  
elegant,  
**Unico**





# Il sistema Unico / Unico, the system



Unico è il nuovo sistema per porte – ideato da Dnd – che riduce al minimo l'impatto visivo della rosetta sulla maniglia, valorizzandone così il design: una soluzione tecnica ed estetica ideale per gli ambienti contemporanei.

Grazie al suo piccolo volume, risulta poco visibile: misura solo 30 mm di diametro e 2 mm di spessore.

Il sistema, proposto in forma rotonda, è facile da installare e prevede la realizzazione di un foro da 22 mm sulla porta.

*Unico is the new system for doors – designed by Dnd – that minimises the visual impact of the rose on the handle, thus enhancing its design: a technical and aesthetic solution that is ideal for contemporary interiors.*

*Thanks to its small volume, it is hardly visible: it measures only 30 mm in diameter and 2 mm in thickness.*

*The system, which comes in a round shape, is easy to install and requires a 22 mm hole to be drilled in the door.*



**san**  
ZNE

032-



**boole**  
PCS

U

Sistema disponibile  
su 23 modelli in  
tutte le loro finiture  
*System available  
on 23 models in all  
their finishes*

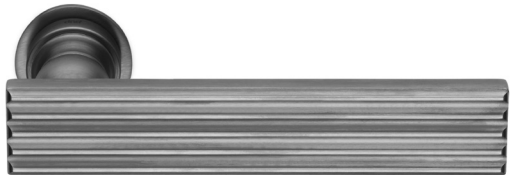

**eleonora**  
PGS | forte®



**ginkgo biloba**  
PVD-BG | forte®

**nottolino e bocchette /  
turn & release and escutcheons**



2413 + A



BD80Y



BD80P



034-

**ginkgo**  
PCS

## Sistema Unico disponibile anche per finestre / *Unico System available also for windows*

Il nuovo sistema Unico è disponibile anche per serramenti, su cui la discrezione della rosetta – di soli 34 mm di diametro e 10 mm di spessore – esalta pienamente la forma e il disegno della maniglia.

Sistema DK a 8 scatti, facile da installare con la realizzazione di un foro da 13 mm sul serramento.

*The new Unico system is also available for windows, where the discretion of the rose – just 34 mm in diameter and 10 mm in thickness – fully enhances the shape and design of the handle.*

*DK 8 position-system, easy to install by drilling a 13 mm hole in the frame.*



**luce P**  
ZCS

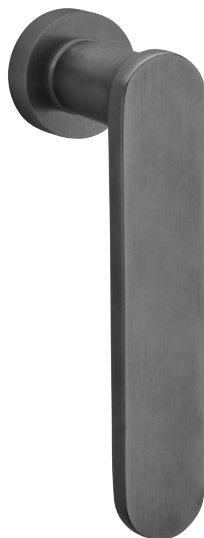

**short**  
PGS|forte®



**san**  
ZCS

# Sistema Less is fine 4 mm / Less is fine system 4 mm

FINE

FINE

Porta / Door

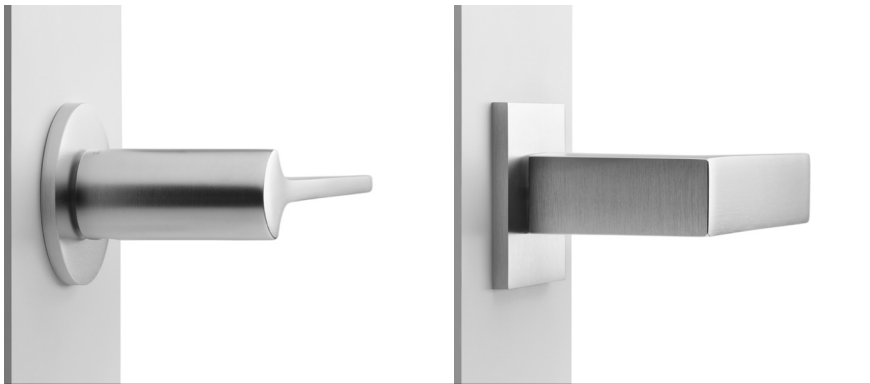

Il sistema Less is fine – di soli 4 mm – nasce grazie alle nuove tendenze dell'architettura. In soli 4 mm si trova la rosetta metallica con con molla uni-direzionale destra o sinistra – a compressione –, la quale permette un'installazione senza lavorazioni aggiuntive sulla porta. Brevetto Dnd.

*The Less is fine system has a thickness of just 4 mm. It has been developed in tune with the latest design trends. A patented uni-directional left or right spring-loaded metal backplate facilitates installation. Dnd patent.*

# Sistema VIS 7 mm / VIS 7 mm system

VIS

VIS

## Porta / Door



Componenti realizzati in nylon PA6 con molla uni-direzionale destra o sinistra. Rosette con diametro 50 mm e spessore 7 mm. Fori per fissaggio legno e interasse 38 mm per viti a connessione con o senza bussole.

Il sistema e la molla interna sono stati testati e certificati dal Laboratorio AQM - Cert.2012-1000/PPE, in base all normativa UNI EN 1906.

*The parts are made with PA6 nylon, with uni-directional left or right spring. The backplate has a diameter of 50 mm and a thickness of 7 mm. Holes for attachment to wood, 38 mm centering, with or without connector nuts.*

*The inner spring and system are certified by AQM - Cert.2012-1000/Ppe in keeping with UNI EN 1906 standards.*

Test di tenuta e usura dei componenti meccanici. Simulazione di apertura e chiusura oltre 200.000 cicli.

**Categoria d'uso** Grado 3: alta frequenza d'uso da parte del pubblico o scarsa cura; alte

probabilità d'uso improprio.

**Durabilità** Grado 7: frequenza d'uso elevata 200.000 cicli.

**Azionamento** Tipo B, serrature caricate a molla.

*Mechanical components wear and tear test.*

*Opening and closing simulation to more than 200.000 cycles.*

**Category of use** Grade 3: High frequenc of use by the public or others with little incentive to

*exercise care and with a high chance of misuse.*

**Durability** Grade 7: high frequency of use 200.000 cycles.

**Type of operation** B spring-loaded furniture.

# Sistema 52 - 10 mm / 52 - 10 mm system

52

52

## Porta / Door

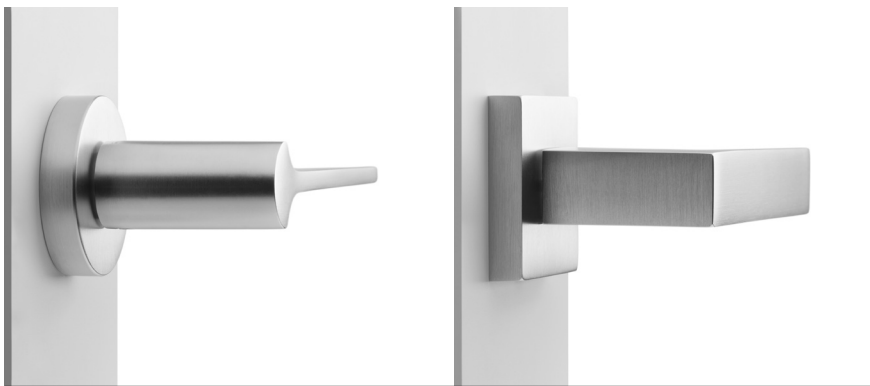

Componenti realizzati in metallo con molla bi-direzionale destra/sinistra.  
Rosette con diametro 52 mm e spessore 10 mm. Fori per fissaggio legno e interasse 38 mm per viti a connessione con o senza bussole.

*The parts are in metal, with bi-directional left/right spring.  
The backplates have a diameter of 52 mm and a thickness of 10 mm. Holes for attachment to wood, 38 mm centering, with or without connector nuts.*

## Componenti tecnici / Technical components

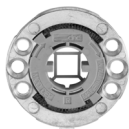

Less is fine



VIS



VIS

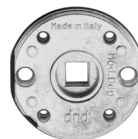

52



# DK VIS 9 mm



# DK VIS TS 9 mm



## Finestra / Window



Il DK VIS nasce dall'esigenza di ottenere un sistema esteticamente combinato con il sistema VIS per porta.

Le componenti tecniche restano così più discrete e lasciano pieno spazio al design della maniglia. Un meccanismo facile e veloce da montare, senza la necessità di lavorazioni sul serramento.

*DK VIS is the result of the need for aesthetic coordination with the VIS system for doors. The technical components remain more discreet to offer greater freedom in the design of the handle. The mechanism is easy and quick to assemble.*

### **Il DK anti intrusione con pulsante di sicurezza.**

Sempre in 9 mm, sempre senza lavorazioni. Studiato appositamente per evitare che, forando il serramento dall'esterno, sia possibile azionare il meccanismo. TSDK non richiede lavorazioni e può essere installato anche in sostituzione a modelli precedenti. Inoltre è configurabile con tutti i modelli a catalogo.

### **The DK anti-intrusion model with security latch.**

*Still with a thickness of 9 mm, without the need for complicated installation operations. Specially designed to avoid the possibility of opening by drilling from the outside. TSDK does not require machining and can also be installed in place of previous models. It can also be coordinated with all the models in the catalogue.*

# legenda / summary

## Porta / Door

- VIS** 50x7 mm  
rosetta-bocchetta tonda  
*round rose-escutcheon*
- FINE** 50x4 mm  
rosetta-bocchetta tonda  
*round rose-escutcheon*
- 52** 52x10 mm  
rosetta-bocchetta tonda  
*round rose-escutcheon*
- B** 50x10 mm  
rosetta-bocchetta tonda bombata  
*rounded rose-escutcheon*
- R** rosetta-bocchetta speciale  
*special rose-escutcheon*
- V** rosetta-bocchetta ovale  
*oval rose-escutcheon*
- S** 31x62x10 mm  
rosetta-bocchetta stretta ovale  
*narrow oval rose-escutcheon*
- U** 30x2 mm  
rosetta minimal UNICO  
*minimal UNICO rose*
- U** 25x2 mm  
bocchetta minimal UNICO  
*minimal UNICO escutcheon*
- VIS** 50x7 mm  
rosetta-bocchetta quadra  
*square rose-escutcheon*
- FINE** 50x4 mm  
rosetta-bocchetta quadra  
*square rose-escutcheon*
- 45** 45x10 mm  
rosetta-bocchetta quadra  
*square rose-escutcheon*
- 52** 52x10 mm  
rosetta-bocchetta quadra  
*square rose-escutcheon*
- R** rosetta-bocchetta speciale quadra  
*special square rose-escutcheon*
- S** 31x62x10 mm  
rosetta-bocchetta stretta rettangolare  
*narrow rectangular rose-escutcheon*

## Finestra / Window

- VIS** 31x64x9 mm  
rosetta ovale per DK VIS  
*DK VIS oval rose*
- U** 31x64x9 mm  
rosetta ovale per DK VIS TS - sicurezza  
*DK VIS TS oval rose for security latch*
- U** 34x10 mm  
rosetta minimal UNICO per DK  
*DK minimal UNICO rose*
- VIS** 31x64x9 mm  
rosetta rettangolare per DK VIS  
*DK VIS rectangular rose*
- U** 31x64x9 mm  
rosetta rettangolare per DK VIS TS - sicurezza  
*DK VIS TS rectangular rose for security latch*
- R** 31x64x12 mm  
rosetta DND rettangolare pesante per DK  
*DND rectangular heavy rose for DK*

NEW

NEW

NEW

finiture

– finishes

# finiture / finishes

## Finiture su ottone / Brass finishes

<b>OLV</b>	Lucido <i>Polished</i>	<b>FAN</b>	Ferro anticato <i>Antique iron</i>
<b>OS</b>	Satinato <i>Satin</i>	<b>OBN</b>	Bianco <i>White</i>
<b>SO</b>	Sabbiato opaco <i>Matt sandblasted</i>	<b>BNL</b>	Bianco lucido <i>Bright white</i>
<b>ORO</b>	Placcato oro 24K <i>Gold plated 24K</i>	<b>ONO</b>	Nero <i>Black</i>
<b>OROF</b>	Oro francese antico <i>French antique gold</i>	<b>V702</b>	Marrone scuro <i>Dark brown</i>
<b>OGC</b>	Bronzo satinato lucido <i>Bright satin bronze</i>	<b>OVE</b>	Verde <i>Green</i>
<b>OGH</b>	Bronzo satinato opaco <i>Matt satin bronze</i>	<b>TAN</b>	Antracite <i>Anthracite</i>
<b>AF</b>	Anticato <i>Antique finish</i>		<b>forte®</b>
<b>BSS</b>	Bronzo scuro sfumato <i>Shaded dark bronze</i>		<b>Finiture PVD su ottone / PVD finishes on brass</b>
<b>AB</b>	Bronzato <i>Antique bronze</i>	<b>PVD forte®</b>	Ottone lucido <i>Polished brass</i>
<b>OC</b>	Power cromo lucido <i>Power polished chrome</i>	<b>PVD-BG forte®</b>	Oro antico lucido <i>Antique bright gold</i>
<b>PCS</b>	Power cromo satinato <i>Power satin chrome</i>	<b>PVD-SG forte®</b>	Oro antico satinato <i>Antique satin gold</i>
<b>OCS</b>	Cromo satinato <i>Satin chrome</i>	<b>PVD-SCB forte®</b>	Rame satinato <i>Satin copper</i>
<b>CCS</b>	Cromo - Power cromo satinato <i>Chrome - Power satin chrome</i>	<b>PGS forte®</b>	Grafite satinato <i>Satin graphite</i>
<b>ONV</b>	Nickel lucido <i>Polished nickel</i>	<b>PVX forte®</b>	Inox satinato <i>Satin steel</i>
<b>ONS</b>	Nickel satinato <i>Satin nickel</i>		

<b>Finiture su zama / Zamak finishes</b>		<b>Finiture su alluminio / Aluminium finishes</b>	
<b>ZOS</b>	Ottonato satinato <i>Satin brass color</i>	<b>ACS</b>	Cromo satinato <i>Satin chrome</i>
<b>ZGH</b>	Bronzo satinato opaco <i>Matt satin bronze</i>	<b>ASV</b>	Silver <i>Silver</i>
<b>ZC</b>	Cromo lucido <i>Polished chrome</i>	<b>ARO</b>	Oro satinato <i>Satin gold</i>
<b>ZCS</b>	Cromo satinato <i>Satin chrome</i>	<b>ABR</b>	Bronzo <i>Bronze</i>
<b>ZNS</b>	Nickel satinato <i>Satin nickel</i>	<b>ABN</b>	Bianco <i>White</i>
<b>ZBN</b>	Bianco <i>White</i>	<b>ANE</b>	Nero <i>Black</i>
<b>ZNE</b>	Nero <i>Black</i>	<b>AAN</b>	Antracite <i>Anthracite</i>
<b>ZAN</b>	Antracite <i>Anthracite</i>	<b>ABT</b>	Turchese <i>Turquoise</i>
		<b>AVP</b>	Violetto pastello <i>Pastel violet</i>
		<b>AGO</b>	Giallo oliva <i>Yellow olive</i>
		<b>ABC</b>	Blu colomba <i>Blue dove</i>
<b>Finiture su acciaio inox / Stainless steel finishes</b>			
<b>S304</b>	Acciaio AISI 304 satinato <i>AISI 304 satin steel</i>		
<b>S316</b>	Acciaio AISI 316 satinato <i>AISI 316 satin steel</i>		
<b>L316 + R</b>	AISI 316 lucido + inserto rame PVD / <i>AISI 316 polished + PVD copper insert</i>		
<b>S316 + R</b>	AISI 316 satinato + inserto rame PVD / <i>AISI 316 satin + PVD copper insert</i>		
<b>L316 + N</b>	AISI 316 lucido + inserto rame nero / <i>AISI 316 polished + copper black insert</i>		
<b>S316 + N</b>	AISI 316 satinato + inserto rame nero / <i>AISI 316 satin + copper black insert</i>		

# forte®

## **PVD, alta qualità nella tecnologia del rivestimento**

**forte®** è il termine coniato da Dnd per identificare e dare enfasi alla speciale finitura per maniglie che si ottiene grazie alla tecnologia di rivestimento PVD.

Acronimo di **Physical Vapour Deposition**, PVD è una tecnologia di rivestimento per prodotti di alta qualità dalle eccellenti caratteristiche chimiche e tecniche, quali alta durezza, resistenza all'abrasione, ai graffi e alla corrosione.

Un rivestimento che è **perfettamente sostenibile**, a impatto ambientale ridotto e **ipoallergenico**.

## **PVD: high quality in coating technology**

**forte®** is the term coined by Dnd to identify and emphasise the special finish for handles that is achieved thanks to PVD coating technology.

An acronym for **Physical Vapour Deposition**, PVD is a coating technology for high quality products with excellent chemical and technical characteristics, such as high hardness, resistance to abrasion, scratching and corrosion.

A coating that is **perfectly sustainable**, with low environmental impact and it is **hypoallergenic**.

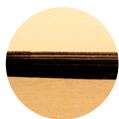

**PVD-BG  
forte®**

oro antico  
lucido /  
*polished*  
*antique gold*



**PVD-SG  
forte®**

oro antico  
satinato /  
*antique*  
*satin gold*



**PVD-SCB  
forte®**

rame  
satinato /  
*satin*  
*copper*



**PGS  
forte®**

grafite  
satinato /  
*satin*  
*graphite*

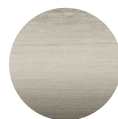

**PVX  
forte®**

inox  
satinato /  
*satin*  
*steel*

**levante**  
Maurizio Varatta



# **PVD-BG | forte®** Oro antico lucido / *Antique bright gold*

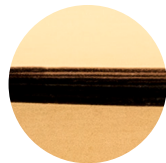

---

**PVD-BG | forte®**  
**Oro antico lucido.**

Il colore dell'ottone proposto in una tonalità più calda: per un segno brillante e luminoso, dal fascino intramontabile.  
Finitura garantita 20 anni.

**PVD-BG | forte®**  
***Antique bright gold.***

*The color of brass in a warmer tone: for a bright, luminous presence of timeless charm.  
Finish guaranteed for 20 years.*



madeleine  
Inga Sempé

forte®



# **PVD-SG | forte®** Oro antico satinato / *Antique satin gold*



---

**PVD-SG | forte®**  
**Oro antico satinato.**

Solido, raffinato e senza tempo, un tono dell'ottone in grado di valorizzare al meglio sia ambienti dal sapore di un tempo, sia interni dal disegno minimale. Finitura garantita 20 anni.

**PVD-SG | forte®**  
***Antique satin gold.***

*Solid, refined and timeless, a tone of brass that is at its best in settings with the spirit of bygone days, but also in contexts of minimalist design. Finish guaranteed for 20 years.*

**ginkgo**  
Giulio lacchetti

**forte**®



# **PVD-SCB | forte®** Rame satinato / *Satin copper*



---

**PVD-SCB | forte®**  
**Rame satinato.**

Ottone con finitura rame, satinato.  
Dall'aspetto prezioso e dal grande fascino,  
il colore del rame sorprende e valorizza  
maniglie accolte in interni domestici dal  
carattere ricercato e dalla forte identità.  
Finitura garantita 10 anni.

**PVD-SCB | forte®**  
**Satin copper.**

*Brass with satin copper finish.  
With a precious image of great charm,  
the color of copper surprises and enhances  
handles in domestic interiors with an  
elegant character of forceful identity.  
Finish guaranteed for 10 years.*

**drop**  
Cino Zucchi

**forte**®



# PGS | forte®

## Grafite satinato / *Satin graphite*



---

**PGS | forte®**  
**Grafite satinato.**

Ottone con finitura grafite, satinato.  
Un tono tra il grigio scuro e il nero: un  
colore originale per far emergere l'oggetto  
maniglia in ambienti connotati da una  
grande attenzione al progetto.  
Finitura garantita 10 anni.

**PGS | forte®**  
***Satin graphite.***

*Brass with satin graphite finish.  
A tone between dark gray and black: an  
original color to make the handle stand out  
in contexts of great design refinement.  
Finish guaranteed for 10 years.*

blend  
967arch

forte®



# PVX | forte®

Inox satinato /  
*Satin steel*

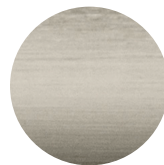

---

**PVX | forte®**  
**Inox satinato.**

Ottone con finitura Inox.  
La tonalità contemporanea dell'acciaio  
inossidabile satinato, perfettamente  
adattabile ad ambienti domestici e pubblici.  
Finitura garantita 20 anni.

**PVX | forte®**  
**Satin steel.**

*Brass with stainless steel finish.  
The contemporary tone of satin-finish  
stainless steel adapts perfectly to both  
domestic and public spaces.  
Finish guaranteed for 20 years.*



**boole**  
Odo Fioravanti

**forte**®



altre finiture

– more finishes

---

## **Finiture cromate / Chrome finishes**

Finiture galvaniche da cromo e nickel  
per superfici lucide e satinare.

*Chrome and nickel galvanic finishes for  
polished and brushed surfaces.*



**OC**  
Power cromo lucido  
*Power polished chrome*



**PCS**  
Power cromo satinato  
*Power satin chrome*



**ONV**  
Nickel lucido  
*Polished nickel*



**ONS**  
Nickel satinato  
*Satin nickel*

---

## Finiture dorate / Golden finishes

Il prestigio dell'ottone reso brillante o satinato tramite spazzolature e finiture artigianali realizzate da mani esperte. Placcature di oro 24K per rendere ancora più raffinate le superfici.

*The prestige of brass, honed or satined by brushing and handmade finishing by skilled artisans. The 24K gold plating makes the surfaces even more refined.*

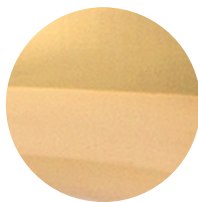

**ORO**  
Placcato oro 24K  
*Gold plated 24K*



**OROF**  
Oro francese antico  
*French antique gold*



**OLV**  
Lucido  
*Polished*



**OS**  
Satinato  
*Satin*



**SO**  
Sabbiato opaco  
*Matt sandblasted*

---

## **Finiture bronzate / Bronze finishes**

Bronzature e graffiature con verniciatura opaca. L'unicità di un materiale come l'ottone rende possibile una realizzazione molto raffinata.

*Bronze coating and texturing with matt varnish. The unique character of brass in an exceptionally refined interpretation.*



**AB**  
Bronzato  
*Antique bronze*



**OGH**  
Bronzo satinato opaco  
*Matt satin bronze*



**BSS**  
Bronzo scuro sfumato  
*Shaded dark bronze*

---

## **Finiture anticate / Antique finishes**

Finiture anticate, ottenute grazie a specifici processi di invecchiamento dell'ottone.

*Antique finishes creating with special aging processes for brass.*

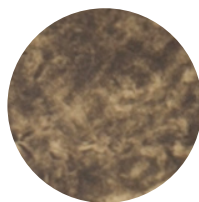

**AF**  
Anticato  
*Antique finish*

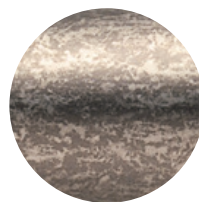

**FAN**  
Ferro anticato  
*Antique iron*

---

## Finiture colorate RAL / RAL colors finishes

Toni inediti e originali per dare spazio alla creatività.

*New, original tones to give room for creativity.*



**BNL**  
Bianco lucido  
*Bright white*



**OBN**  
Bianco  
*White*

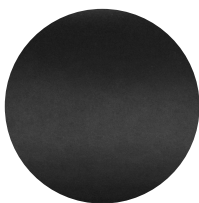

**ONO**  
Nero  
*Black*



**V702**  
Marrone scuro  
*Dark brown*

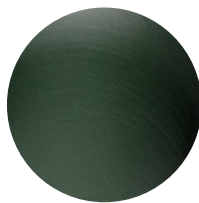

**OVE**  
Verde  
*Green*

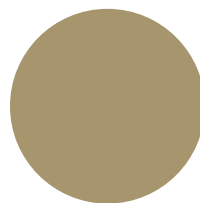

**AGO**  
Giallo oliva  
*Yellow olive*

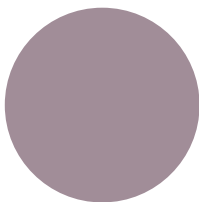

**AVP**  
Violetto pastello  
*Pastel violet*

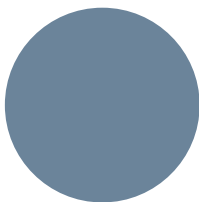

**ABC**  
Blu colomba  
*Blue dove*

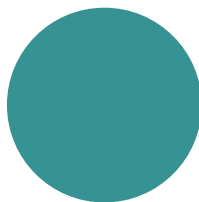

**ABT**  
Turchese  
*Turquoise*

# resistenza al fuoco / *fire resistance*

---

## **Attestati di resistenza al fuoco EN 1634-2 ED. 2008**

Test di resistenza al fuoco e al fumo per porte, finestre, serrature e componenti di ferramenta da costruzione.

I prodotti Dnd possono essere utilizzati per installazioni su porte e finestre che hanno ottenuto la certificazione EN 1634-2 e che hanno dimostrato di possedere la medesima resistenza al fuoco.

## **Attestation of fire resistance EN 1634-2 ED. 2008**

*Fire resistance and smoke control tests for door, shutter and openable window assemblies and elements of building hardware.*

*The Dnd products can be used for installation on doors and openable windows of similar type that had been tested according to EN 1634-2, and have been shown to have at least the same fire resistance.*



– design



maniglie  
design

handles

pod NEW





Una serie realizzata con una lavorazione dedicata e originale: un tondino di materiale viene tornito alle estremità e opportunamente inclinato di 45 gradi, per generare un gesto dinamico ed equilibrato sull'orizzontalità della leva.

*A series created with a dedicated and original manufacturing process: a rod of material is turned at each end and carefully bent at a 45 degrees angle, making for a dynamic and balanced gesture on the horizontal bar of the lever.*

**pod**

**design:**  
**Holscher Design**

made in italy



**PD40**  
PCS

066-

**dnd**22-23

Ottone stampato a caldo  
*Hot stamped brass*

**new 2022**



**OLV**  
Lucido  
*Polished*



**OC**  
Power cromo lucido  
*Power polished chrome*



**PCS**  
Power cromo satinato  
*Power satin chrome*



**ONO**  
Nero  
*Black*



**PVD-BG | forte®**  
Oro antico lucido  
*Antique bright gold*



**PVD-SG | forte®**  
Oro antico satinato  
*Antique satin gold*



**PGS | forte®**  
Grafite satinato  
*Satin graphite*

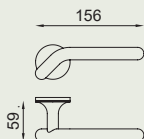

**FINE** PD40



PD27

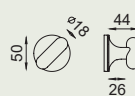

RDN77+A

# Holscher Design



Studio di progettazione multidisciplinare con base a Copenhagen, in Danimarca, è attivo dal 1990 e si colloca tra le più riconosciute e premiate agenzie di progettazione della Scandinavia. Holscher Design è diretto da un team di cinque soci, è fortemente radicato nella tradizione dei Paesi del Nord e sviluppa progetti a livello internazionale in diversi ambiti, tra cui illuminazione, sanitari, componenti per l'edilizia, design urbano. Tra le collaborazioni, Geberit, Flos, JCDecaux, Philips, Lamy.

*A multidisciplinary design firm based in Copenhagen, Denmark, Holscher Design has been active since 1990 and is amongst the most well-established and award-winning design agencies in Scandinavia. The studio is headed up by a team of five partners, with deep roots in the tradition of the Nordic countries, and develops international projects spanning various fields, including lighting, sanitaryware, construction components and urban design. Its many collaborations include Geberit, Flos, JCDecaux, Philips and Lamy.*

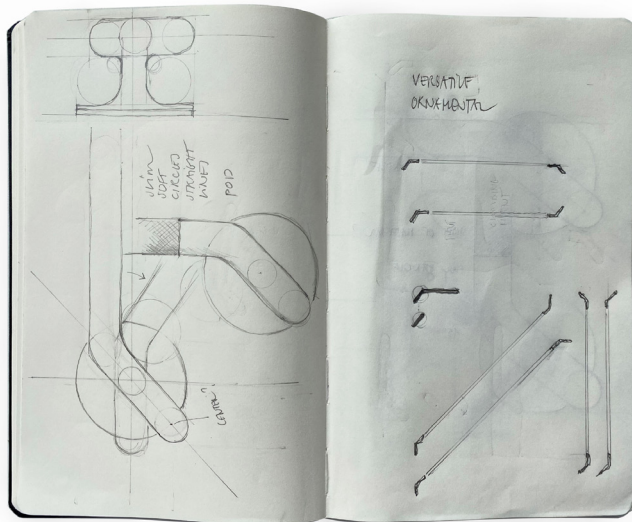

**Pod**  
Disegni della maniglia di /  
Handle sketches by  
Holscher Design



Pantone Universe Table Setting, Room Copenhagen (2010)



Pure, Flos (2007)



Camera, Flos (2020)

**san** **NEW**







Come a ricordare l'elegante e slanciato profilo di una katana. Curve morbide e in tangenza caratterizzano questa originale maniglia dall'estetica e dal nome, di ispirazione giapponese.

*Delicately reminiscent of the elegant, slender profile of a katana. Soft, tangential curves characterise this original handle with a Japanese-inspired name and aesthetic.*

**san**

**design:**  
**Philippe Tabet**

made in italy



**SN12**  
ZOS

072-

**dnd**22-23

Zama  
Zamak

new 2022



**ZC**  
Cromo lucido  
*Polished chrome*



**ZCS**  
Cromo satinato  
*Satin chrome*



**ZNE**  
Nero  
*Black*



**ZAN**  
Antracite  
*Anthracite*

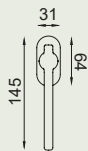
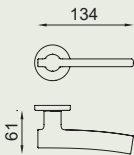

**VIS** SN12

**U** SN80

**VIS** SN22V

**U** SN22TS

**U** SN22U

# san 02

design:  
Philippe Tabet

made in italy



SN14  
ZNE

074-

dnd/22-23

Zama  
Zamak

new 2022



**ZC**  
Cromo lucido  
*Polished chrome*



**ZCS**  
Cromo satinato  
*Satin chrome*



**ZNE**  
Nero  
*Black*



**ZAN**  
Antracite  
*Anthracite*

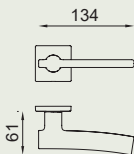

**VIS** SN14

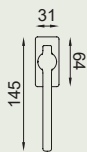

**VIS** SN25V

 SN25TS

# Philippe Tabet



Nato e cresciuto in Francia, a Versailles, ha studiato design industriale a Lione e Parigi. Vive a Milano, dove dal 2014 ha sede il suo studio di progettazione e dove insegna presso Domus Academy e Naba. Collabora con aziende rinomate quali Pianca, Lexon, Infiniti Design e Plust e al contempo sviluppa un suo percorso artigianale, con processi e risultati che esplorano materiali e tecniche di lavorazione – come per la serie di maschere Order. Ha vinto il premio Infiniti Design nel 2014 e Young&Design nel 2017; ha ottenuto il Good Design Award nel 2018.

*Born and raised in Versailles, France, he studied industrial design in Lyon and Paris. He now lives in Milan, where he established his design firm in 2014 and where he teaches at Domus Academy and Naba. He collaborates with renowned companies such as Pianca, Lexon, Infiniti Design and Plust, whilst at the same time following his own path as a craftsman, with processes and results that are explorations of materials and techniques, as can be seen from Order, his series of masks. He won the Infiniti Design award in 2014 and the Young&Design award in 2017, before garnering the Good Design Award in 2018.*

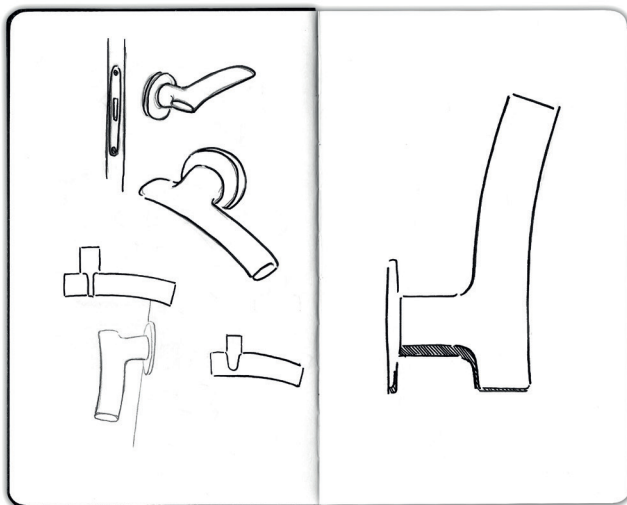

San  
Disegni della maniglia di /  
Handle sketches by  
Philippe Tabet



Order, autoproduzione / self production (2017)



Slide, Lexion (2017)



Fushimi Lounge, Pianca (2020)

**eleonora** 

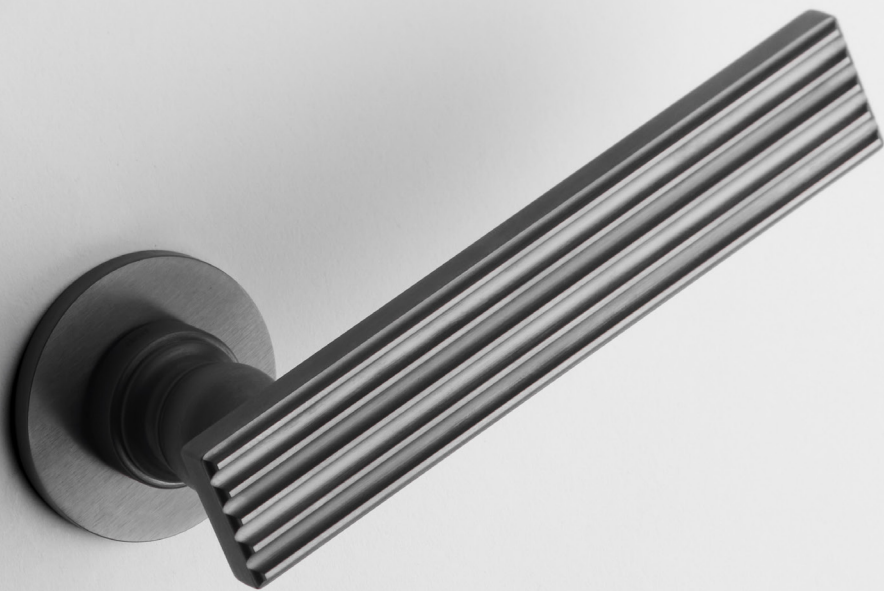





Sottili scanalature per l'impugnatura, in omaggio allo stile ionico; e un modellato morbido ma rigoroso per lo stelo: una maniglia che guarda agli stili della storia, in equilibrio tra antica Grecia e Rinascimento.

*Subtle grooves in the handle, redolent of the Ionic style, along with a soft yet rigorous shape for the stem: a handle that draws upon styles from throughout history, carefully balanced between Ancient Greece and the Renaissance.*

# eleonora

design:  
**Marco Pisati**

made in italy

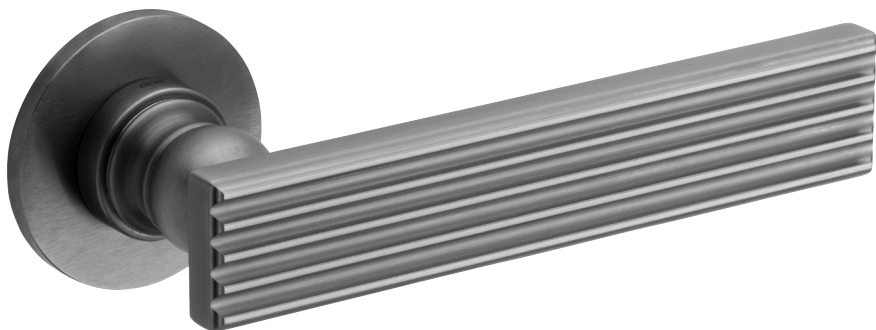

**EL40**  
PGS|forte®

080-

**dnd**22-23

Ottone forgiato  
Forged brass

new 2022



**OGH**  
Bronzo satinato opaco  
*Matt satin bronze*



**ONV**  
Nickel lucido  
*Polished nickel*



**PVD-BG | forte®**  
Oro antico lucido  
*Antique bright gold*



**PVD-SG | forte®**  
Oro antico satinato  
*Antique satin gold*



**PGS | forte®**  
Grafite satinato  
*Satin graphite*

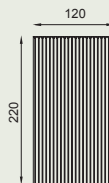
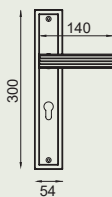
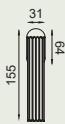
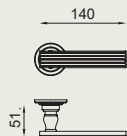

**FINE** EL40

**VIS** EL22V

EL10

EL27 singolo

EL29 singolo

**R** EL13

**U** EL22U

EL28 set

EL30 set

**U** EL80

# eleonora 02

design:  
Marco Pisati

made in italy



EL41  
OGH

082-

dnd/22-23

Ottone forgiato  
*Forged brass*

**new 2022**



**OGH**  
Bronzo satinato opaco  
*Matt satin bronze*



**ONV**  
Nickel lucido  
*Polished nickel*



**PVD-BG | forte®**  
Oro antico lucido  
*Antique bright gold*



**PVD-SG | forte®**  
Oro antico satinato  
*Antique satin gold*

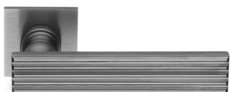

**PGS | forte®**  
Grafite satinato  
*Satin graphite*

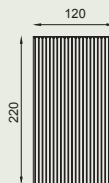
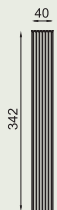
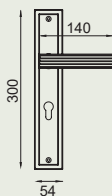
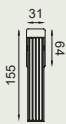
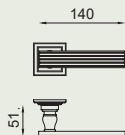

**FINE** EL41

**R** EL25

EL10

EL27 singolo

EL29 singolo

**R** EL19

EL28 set

EL30 set

# Marco Pisati



Designer fiorentino, architetto di formazione, è affascinato dai nuovi materiali e dalle nuove tecnologie. Sperimenta le sue idee nei settori più diversi, progettando per diverse aziende: ASI (Agenzia Spaziale Italiana), Emilio Pucci, Antonio Lupi, Cordivari, Cristina Rubinetterie, Gattoni Rubinetterie, Treemme Rubinetterie, Glass Design, K8 Radiatori. Diversi i premi e i riconoscimenti ottenuti dai suoi prodotti: Red Dot Design Award, German Design Award, Archiproducts Design Award, ADI Ceramics & Bathroom Design Award.

*A designer from Florence, trained as an architect, fascinated by new materials and technologies. He experiments with ideas in a wide range of sectors, designing for different companies: ASI (Italian Space Agency), Emilio Pucci, Antonio Lupi, Cordivari, Cristina Rubinetterie, Gattoni Rubinetterie, Treemme Rubinetterie, Glass Design, K8 Radiatori. He has been awarded many design awards for his projects: Red Dot Design Award, German Design Award, Archiproducts Design Award, ADI Ceramics & Bathroom Design Award.*

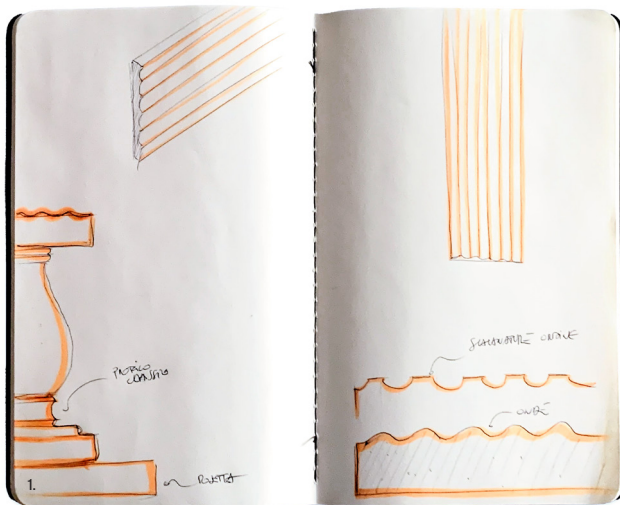

Eleonora  
Disegni della maniglia di /  
Handle sketches by  
Marco Pisati



Tessuto, Cordivari (2020)



Kea, Treemme (2019)



Q30, Treemme (2019)

**freely** 







Un design sobrio ed essenziale, che combina impatto estetico e tratti funzionali attraverso una silhouette perfettamente ergonomica e mai invasiva, costituita da un unico elemento sinuoso che trova nella cavità centrale la sua peculiarità differenziante.

*A sober and essential design, which combines beauty and functional features through a perfectly ergonomic and never-invasive profile, made up of a single sinuous element presenting a differentiating peculiarity in the central cavity.*

**freely**

**design:**  
**Giulio lacchetti**

made in italy



**FR01**  
ACS

088-

**dnd**22-23

Alluminio  
*Aluminium*

**new 2022**



**ACS**  
Cromo satinato  
*Satin chrome*



**AAN**  
Antracite  
*Anthracite*



**ANE**  
Nero  
*Black*

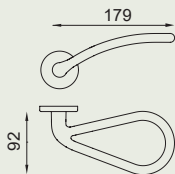

FR01

# Giulio Iacchetti



Con base a Milano, si occupa di industrial design dal 1992. Tra le diverse aziende con cui collabora: Alessi, Artemide, Foscarini, IFI, Magis, Meritalia, Moleskine, Nava, Montini, United Pets. È direttore artistico di diversi brand, tra cui Abet Laminati, Internoitaliano, Pandora design e Dnd. Nel maggio 2009 la Triennale di Milano ha ospitato una sua mostra personale intitolata "Giulio Iacchetti. Oggetti disobbedienti". È stato premiato con due premi ADI Compasso d'Oro (2001 e 2014) e ha ricevuto diversi riconoscimenti internazionali.

*Based in Milan, he is an industrial designer since 1992. Among the companies he works with, Alessi, Artemide, Foscarini, IFI, Magis, Meritalia, Moleskine, Nava, Montini, United Pets. He is artistic director for several brands, including Abet Laminati, Internoitaliano, Pandora design and Dnd. In May 2009 the Triennale di Milano held a solo exhibition titled "Giulio Iacchetti. Disobedient objects". He was awarded two ADI Compasso d'Oro (2001 and 2014) and he has been awarded many international design awards.*

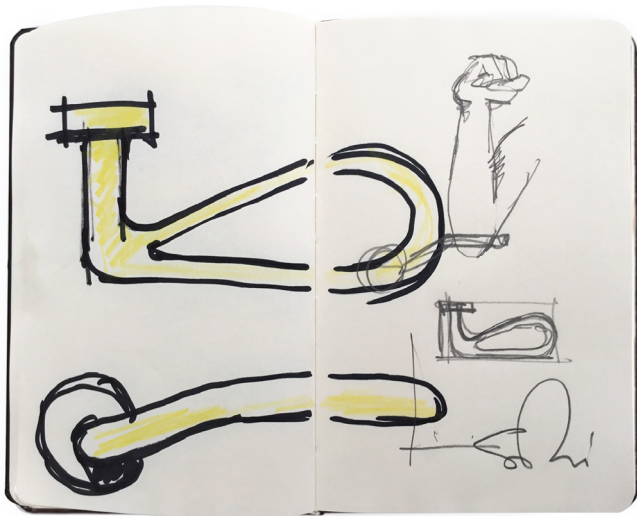

Freely  
Disegni della maniglia di /  
Handle sketches by  
Giulio Iacchetti



Ora In/Ora Out, Alessi (2015)



Moscardino, Pandora Design (2000)



Affi, Internotitaliano (2012)



Classic Collection, Moleskine (2017)

# (IN)finito



**Selezionato  
ADI DESIGN 2019**  
*Selected for  
ADI DESIGN 2019*

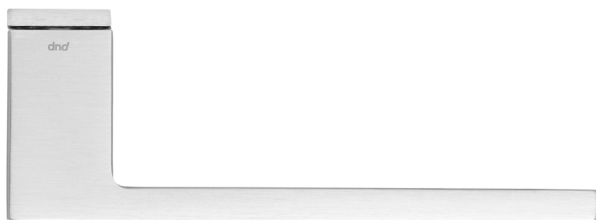

Come un filo bidimensionale che arriva dai bordi della porta, disegna la maniglia e poi continua il suo viaggio, ora verso l'altro lato, ora verso l'alto, ora nell'altra direzione.

*Like a two-dimensional line that arrives from the edges of the door and draws the handle before continuing on its way, towards the other side, upward, in the opposite direction.*

# (IN)finito

design:  
**Alfonso Femia**

made in italy



IF10  
ONO

094-

dnd/22-23



Ottone stampato a caldo  
*Hot stamped brass*



**OLV new**  
Lucido  
*Polished*



**AB new**  
Bronzato  
*Antique bronze*



**SO new**  
Sabbiato opaco  
*Matt sandblasted*



**PCS**  
Power cromo satinato  
*Power satin chrome*



**ONO**  
Nero  
*Black*



**Selezionato ADI DESIGN 2019**  
*Selected for ADI DESIGN 2019*

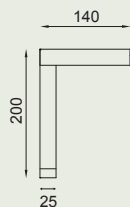

IF10

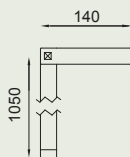

IF10/L  
Placca lunga 1050 mm  
*Long plate 1050 mm*

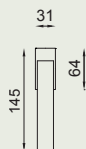

 IF25TS

 IF25

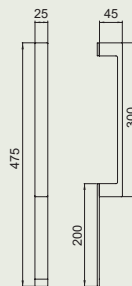

IF29 - singolo

IF30 - set

**(IN)finito** 





Il modello di maniglia  
si declina in diverse  
soluzioni.

*The door handle  
model comes in  
different versions.*

La rosetta diventa  
un elemento minimo  
e si innesta alla base  
della maniglia.

*The rose becomes a  
minimal element and  
gets in position at the  
handle base.*

# (IN)finito

design:  
**Alfonso Femia**

made in italy



**IF01**  
PCS

098-

**dnd**22-23

Ottone stampato a caldo  
Hot stamped brass



**OLV new**  
Lucido  
Polished



**AB new**  
Bronzato  
Antique bronze



**SO new**  
Sabbiato opaco  
Matt sandblasted



**PCS**  
Power cromo satinato  
Power satin chrome



**ONO**  
Nero  
Black

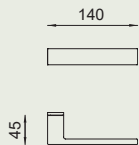

IF01

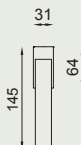

**R** IF25

**🔒** IF25TS

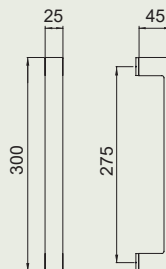

IF27 - SINGOLO

IF28 - SET

# (IN)finito NEW

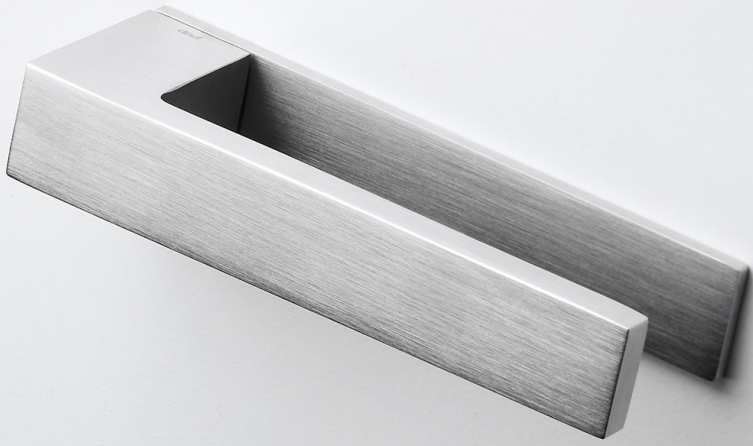



La placca riprende  
il profilo della maniglia,  
si fa sottile e si adatta  
orizzontalmente alla  
superficie della porta.

*The plate is shaped  
like the door handle,  
it becomes thin and  
conforms horizontally  
to the door surface.*

# (IN)finito

design:  
**Alfonso Femia**

made in italy



**IF11**  
OLV

102-

**dnd**22-23



Ottone stampato a caldo  
Hot stamped brass



**OLV new**  
Lucido  
Polished



**AB new**  
Bronzato  
Antique bronze



**SO new**  
Sabbiato opaco  
Matt sandblasted



**PCS**  
Power cromo satinato  
Power satin chrome



**ONO**  
Nero  
Black

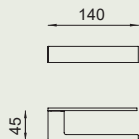

IF11

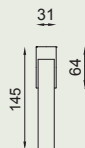

**R** IF25

**🔒** IF25TS

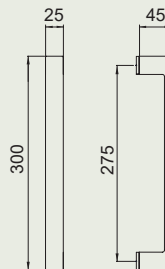

IF27 - SINGOLO

IF28 - SET

# (IN)finito

design:  
**Alfonso Femia**

made in italy

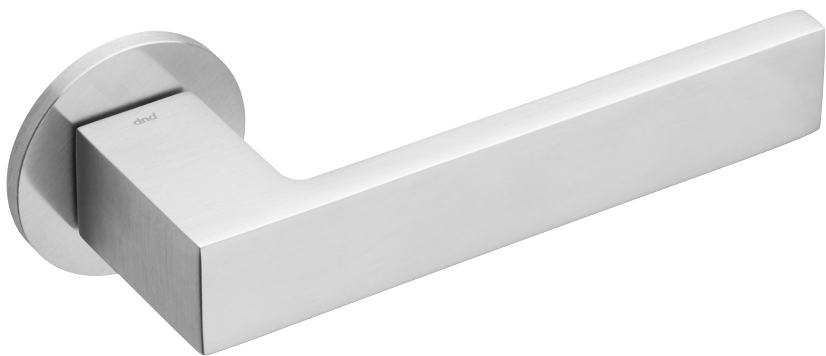

**IF40**  
PCS

104-

**dnd**22-23

Ottone stampato a caldo  
*Hot stamped brass*

**new 2022**



**OLV new**  
Lucido  
*Polished*



**AB new**  
Bronzato  
*Antique bronze*



**SO new**  
Sabbiato opaco  
*Matt sandblasted*



**PCS**  
Power cromo satinato  
*Power satin chrome*



**ONO**  
Nero  
*Black*

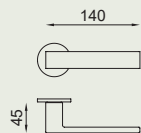

**FINE** IF40

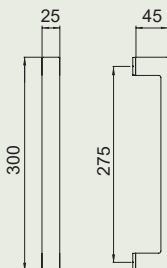

IF27 - SINGOLO

IF28 - SET

# (IN)finito

design:  
Alfonso Femia

made in italy



IF41  
ONO

106-

dnd/22-23

Ottone stampato a caldo  
*Hot stamped brass*

**new 2022**



**OLV new**  
Lucido  
*Polished*



**AB new**  
Bronzato  
*Antique bronze*



**SO new**  
Sabbiato opaco  
*Matt sandblasted*



**PCS**  
Power cromo satinato  
*Power satin chrome*



**ONO**  
Nero  
*Black*

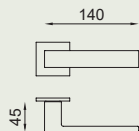

**FINE** IF41

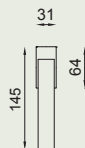

**R** IF25

 IF25TS

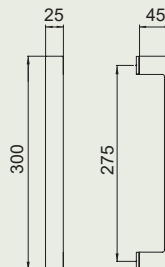

IF27 - SINGOLO

IF28 - SET

# Alfonso Femia

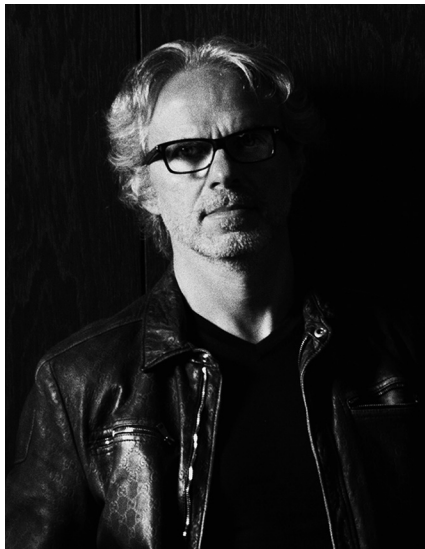

Originario di Taurianova (RC), vive tra Genova, Milano e Parigi. Laureato presso la Facoltà di Architettura dell'Università di Genova nel 1992, è iscritto all'Ordine degli Architetti di Genova, dell'Île-de-France e della Svizzera.

Ha insegnato Progettazione Architettonica alla Kent State University di Firenze, alla Facoltà di Architettura di Ferrara e a quella di Genova. Fondatore di 5+1 nel 1995, crea 5+1AA nel 2005 e 5+1AA Parigi nel 2007. Tra i suoi progetti, la nuova sede BNP Paribas a Roma, i Docks di Marsiglia, le OGR di Torino.

*Born in Taurianova (RC), he lives between Genoa, Milan and Paris. With a degree from the School of Architecture of the University of Genoa in 1992, he is a member of the Architects Associations of Genoa, Île-de-France and Switzerland.*

*He has taught Architectural Design at Kent State University in Florence, and the Schools of Architecture of Ferrara and Genoa. He was a founder of 5+1 in 1995, and created 5+1AA in 2005 and 5+1AA Paris in 2007. His projects include the new BNP Paribas headquarters in Rome, the Docks of Marseille, the OGR in Turin.*

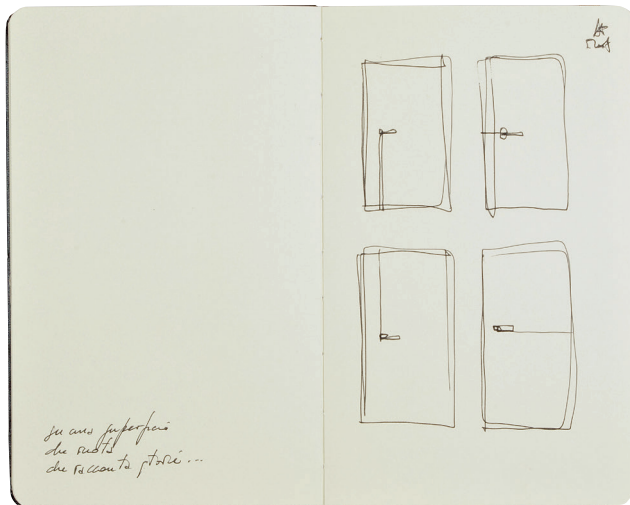

**(IN)finito**  
Disegni della maniglia di /  
Handle sketches by  
Alfonso Femia



Nuova Biblioteca, La Spezia/Italy (2012-2016)

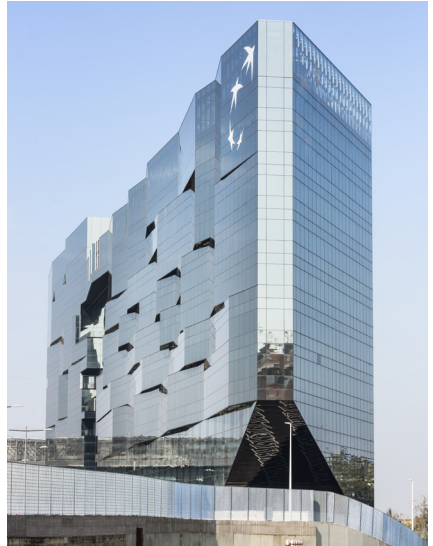

BNL-BNP Paribas Headquarters, Roma/Italy (2012-2017)



I Giardini di Gabriel, Asnières-sur-Seine/France (2013-2016)



Marseilles Docks, Marseille/France (2009-2015)

# DUE







Una soluzione  
dalla forza plastica  
essenziale:  
la sua figura è resa  
primigenia attraverso  
la trasformazione  
dei due tradizionali  
elementi funzionali,  
l'impugnatura e  
la rosetta, in una  
coppia di sottili  
parallelepipedi  
perfettamente  
uguali tra loro.

*A solution of essential  
sculptural force:  
the figure becomes  
primeval through  
the transformation  
of the two traditional  
functional elements,  
the grip and the  
plate, into a pair  
of slender  
parallelepipeds,  
perfectly equal.*

# DUE

design:  
**Stefano Boeri  
Architetti**

made in italy



**DU10**  
PCS

112-

**dnd**22-23

Ottone stampato a caldo  
*Hot stamped brass*



**PCS**  
Power cromo satinato  
*Power satin chrome*



**ONO**  
Nero  
*Black*



**PGS | forte®**  
Grafite satinato  
*Satin graphite*

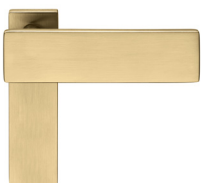

**PVD-SG | forte®**  
Oro antico satinato  
*Antique satin gold*

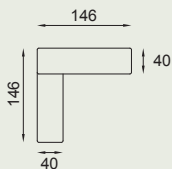

**VIS** DU10

**R** DU25

**🔒** DU25TS

**DUE** **NEW**



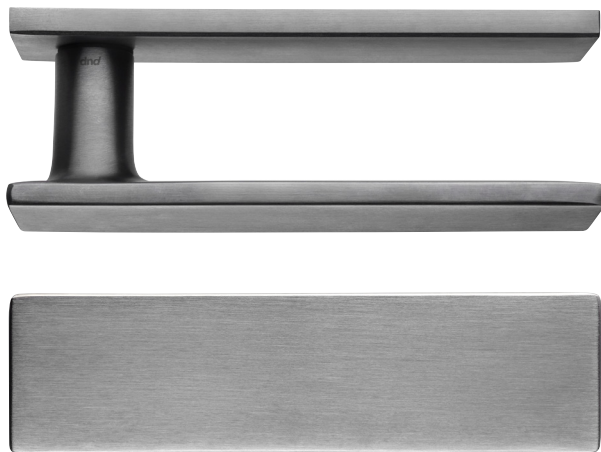

La sovrapposizione di due sottili parallelepipedi tra loro uguali genera un elegante elemento geometrico sulla porta.

*The overlapping of two equal, slender parallelepipeds produces a refined and geometric element on the door.*

# DUE

design:  
**Stefano Boeri  
Architetti**

made in italy



**DU11**  
PVD-SG | forte®

116-

**dnd**22-23

Ottone stampato a caldo  
*Hot stamped brass*

**new 2022**



**PCS**  
Power cromo satinato  
*Power satin chrome*



**ONO**  
Nero  
*Black*



**PGS | forte®**  
Grafite satinato  
*Satin graphite*



**PVD-SG | forte®**  
Oro antico satinato  
*Antique satin gold*

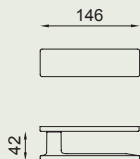

DU11



**R** DU25

**🔒** DU25TS

# DUE

**design:**  
**Stefano Boeri**  
**Architetti**

made in italy

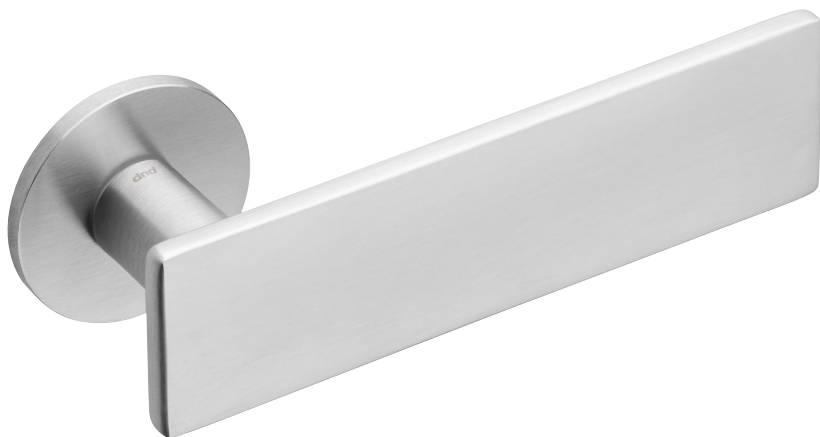

**DU40**  
PCS

118-

**dnd**22-23



Ottone stampato a caldo  
*Hot stamped brass*

**new 2022**



**PCS**  
Power cromo satinato  
*Power satin chrome*



**ONO**  
Nero  
*Black*



**PGS | forte®**  
Grafite satinato  
*Satin graphite*



**PVD-SG | forte®**  
Oro antico satinato  
*Antique satin gold*

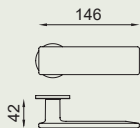

**FINE** DU40

**U** DU80

**VIS** DU25V

**U** DU22U

# DUE

design:  
**Stefano Boeri  
Architetti**

made in italy

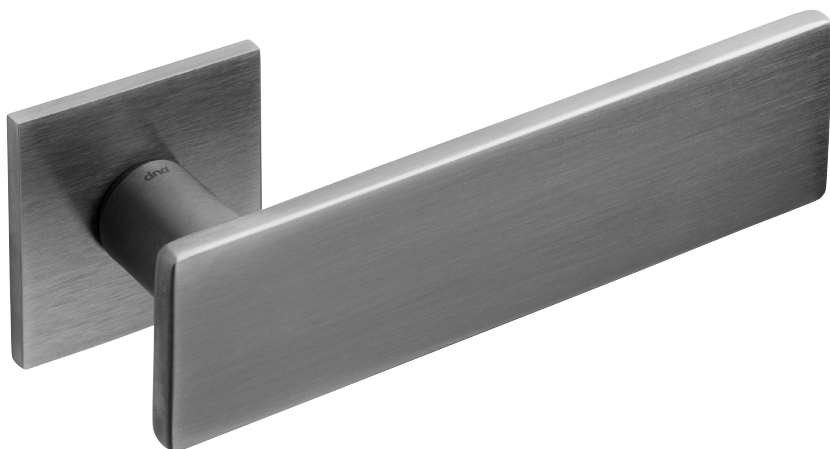

**DU41**  
PGS|forte®

120-

**dnd**22-23

Ottone stampato a caldo  
*Hot stamped brass*

**new 2022**



**PCS**  
Power cromo satinato  
*Power satin chrome*



**ONO**  
Nero  
*Black*



**PGS | forte®**  
Grafite satinato  
*Satin graphite*



**PVD-SG | forte®**  
Oro antico satinato  
*Antique satin gold*

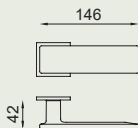

**FINE** DU41

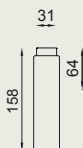

**R** DU25

**🔒** DU25TS

# Stefano Boeri Architetti



Con sede a Milano e uffici a Shanghai (dal 2014) e Tirana (dal 2015), Stefano Boeri Architetti si dedica dal 1993 alla progettazione e alla ricerca, principalmente in ambito architettonico e urbanistico, ma anche culturale, del design e dell'interior design.

Lo studio ha sviluppato progetti architettonici e di rigenerazione in luoghi complessi e in più continenti. Tra i progetti costruiti più noti, il Bosco Verticale di Milano, la Villa Méditerranée a Marsiglia e la Casa del Mare sull'isola de La Maddalena, in Sardegna.

*Based in Milan, with offices in Shanghai (since 2014) and Tirana (since 2015), Stefano Boeri Architetti has focused since 1993 on design and research, mostly in the fields of architecture and urban planning, but also on culture and interior design.*

*The studio has developed projects of architecture and urban regeneration in complex locations and on multiple continents. Outstanding constructed works include the Bosco Verticale in Milan, the Villa Méditerranée in Marseille and the Casa del Mare on the island of La Maddalena, Sardinia.*



## DUE

Disegni della maniglia di /  
Handle sketches by  
Stefano Boeri Architetti



Villa Méditerranée, Marseille/France (2004-2013)



Il polo del gusto, Amatrice/Italy (2016-2017)



Bosco Verticale, Milano/Italy (2009-2014)

# levante





L'essenzialità di una  
forma asciutta e  
semplice, caratterizza  
un oggetto il cui  
disegno si identifica  
con la sua funzione.

*The essence of a  
terse, simple form,  
an object whose  
design would be  
identified with its  
function.*

# levante

design:  
Maurizio Varratta

made in italy



LE40  
PGS|forte®

126-

dnd/22-23



Ottone stampato a caldo  
*Hot stamped brass*



**PCS**  
Power cromo satinato  
*Power satin chrome*



**PGS | forte®**  
Grafite satinato  
*Satin graphite*



**PVD-SCB | forte®**  
Rame satinato  
*Satin copper*



**PVD-SG | forte®**  
Oro antico satinato  
*Antique satin gold*



**PVX | forte®**  
Inox satinato  
*Satin steel*

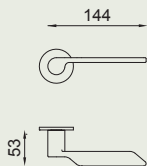

**FINE** LE40

**U** LE80

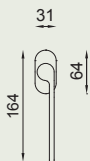

**VIS** LE22V

**U** LE22TS

**U** LE22U





Prysmian Group Headquarters, Milano/Italy (2014-2017)



Auditorium Fiera di Milano, Milano/Italy (2005-2009)



iGuzzini Light Laboratory, Recanati/Italy (2006-2009)

**drop**





Una maniglia dalle  
linee morbide e  
affabili, in cui l'ottone  
si lascia apprezzare  
nella sua forma  
migliore.

*A door handle  
featuring a soft and  
affable shape, in which  
brass conveys its  
allure thanks to the  
best possible form.*

# drop

design:  
**Cino Zucchi**

made in italy



**DP40**  
PVD-SCB | forte®

132-

**dnd**22-23

Ottone stampato a caldo  
*Hot stamped brass*

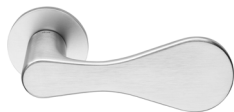

**PCS**  
Power cromo satinato  
*Power satin chrome*



**PGS | forte®**  
Grafite satinato  
*Satin graphite*



**PVD-SG | forte®**  
Oro antico satinato  
*Antique satin gold*



**PVD-SCB | forte®**  
Rame satinato  
*Satin copper*

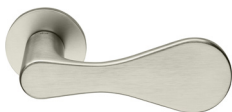

**PVX | forte®**  
Inox satinato  
*Satin steel*

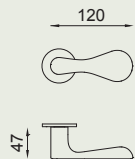

**FINE** DP40

**U** DP80

**VIS** DP22V

**U** DP22TS

**U** DP22U

# Cino Zucchi



Nato a Milano, Cino Zucchi si è laureato in architettura al M.I.T. di Boston e al Politecnico di Milano. Autore di articoli e libri di teoria architettonica e urbana, ha partecipato a varie edizioni della Triennale di Milano e della Biennale di Architettura di Venezia. Insieme allo studio CZA ha progettato e realizzato molti progetti: tra i più noti, quelli della ex Junghans a Venezia, dell'ex Alfa Romeo - Portello Nord e della Corte Verde a Milano; il master plan per Keski Pasila a Helsinki, la nuova sede Lavazza (TO), gli HQ Salewa (BZ).

*Born in Milan, Cino Zucchi has earned degrees in Architectural Design at M.I.T. and at Politecnico di Milano. Author of several articles and books on architectural and urban theory, he has taken part in various editions of the Milan Triennale and of the Venice Biennale of Architecture. With his studio CZA, he has designed and completed a number of projects, including the former Junghans factory site in Venice; the former Alfa Romeo-Portello Nord area and the Corte Verde in Milan; the Keski-Pasila master plan in Helsinki; the Lavazza HQ (TO); and the Salewa HQ (BZ).*

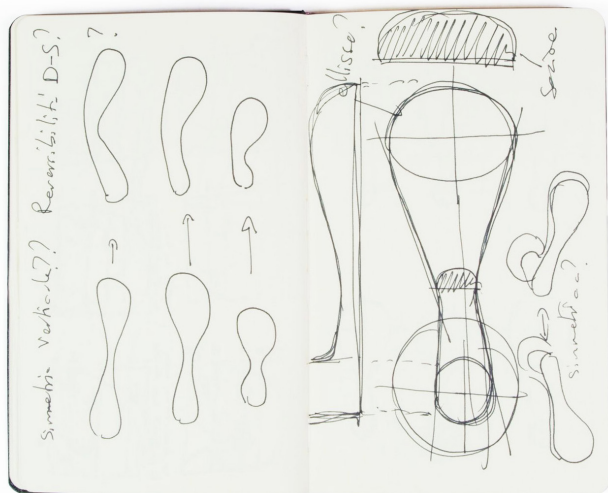

**Drop**  
Disegni della maniglia di /  
Handle sketches by  
Cino Zucchi





La Corte Verde, Milano/Italy (2006-2013)



D Residential Building, Venezia/Italy (1997-2003)



Salewa Headquarters, Bolzano/Italy (2007-2011)



Lavazza Headquarters, Torino/Italy (2010-2017)

**blend**

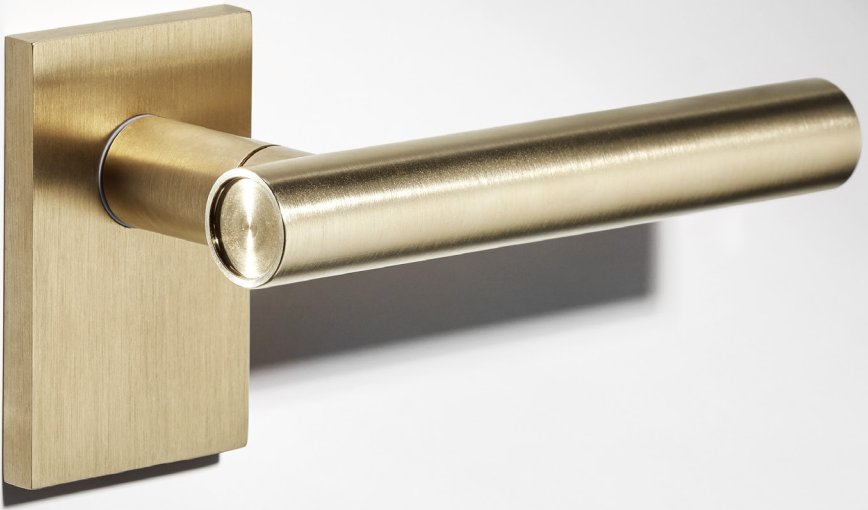



Una maniglia nata dalla volontà di combinare forme elementari, cilindro e rettangolo, nella ricerca di un equilibrio complessivo ma soprattutto di una immediata e percettiva iconicità.

*A handle based on the urge to combine basic forms, a cylinder and a rectangle, in pursuit of an overall balance and above all an immediate perceptive impact.*

**blend**

**design:  
967arch**

made in italy



**BN10/R**  
PCS

138-

**dnd**22-23

Ottone  
Solid brass



**PCS**  
Power cromo satinato  
*Power satin chrome*



**BNL**  
Bianco lucido  
*Bright white*



**PGS | forte®**  
Grafite satinato  
*Satin graphite*



**PVD-SG | forte®**  
Oro antico satinato  
*Antique satin gold*



**PVX | forte®**  
Inox satinato  
*Satin steel*

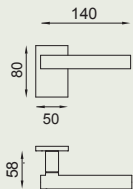

BN10/R

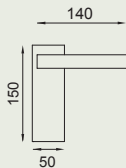

BN10

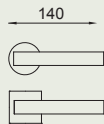

**FINE** BN40

**FINE** BN41

**U** BN80

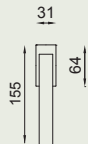

**R** BN25

**🔒** BN25TS

**U** BN22U

# 967arch



Fondato a Milano nel 1999 da Cesare Chichi e Stefano Maestri, lo studio 967arch affianca all'attività di progettazione architettonica e di interior quella di design del prodotto in un continuo passaggio di influenze, sperimentazioni e contaminazioni. Il team ha affrontato progetti su scale differenti, con un focus particolare per le sedi e gli uffici di aziende tra cui Google, Petronas, WPP, Cisco e Ferrero. I progetti di design vedono collaborazioni con aziende come Poltrona Frau, Davide Groppi, Dieffebi, GE Giussani, MDF Italia, Zumtobel e Las Mobili.

*Founded in Milan in 1999 by Cesare Chichi and Stefano Maestri, the firm 967arch combines activities of architectural and interior design with work on products, in a continuous exchange of influences, experimentation and contamination. The team has tackled projects on many different scales, with a particular focus on headquarters and offices for companies like Google, Petronas, WPP, Cisco and Ferrero. The projects of product design include collaborations with companies like Poltrona Frau, Davide Groppi, Dieffebi, GE Giussani, MDF Italia, Zumtobel and Las Mobili.*

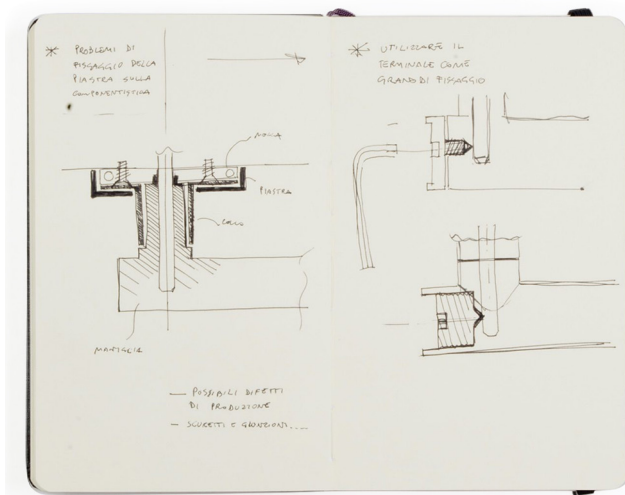

**Blend**  
Disegni della maniglia di /  
Handle sketches by  
967arch



Amplifon Headquarters, Milano/Italy (2016)



Inter San Siro locker room, Milano/Italy (2017)



Cisco (Torri Bianche), Vimercate/Italy (2016)

**viva!**







Una maniglia che nasce dalla fusione dei fondamentali aspetti ergonomici con la sobrietà dell'impatto visivo. Viva! presenta un aspetto diverso a seconda del punto di osservazione, con tratti lineari o morbidi e sinuosi a caratterizzarla.

*A handle based on the fusion of fundamental ergonomic aspects with understated visual impact. Viva! looks different from various vantage points, with linear or soft, sinuous features.*

**viva!**

**design:**  
**Luca Nichetto**

made in italy



**VV40**  
PGS|forte®

144-

**dnd**22-23

Ottone stampato a caldo  
*Hot stamped brass*



**OGH**  
Bronzo satinato opaco  
*Matt satin bronze*



**PCS**  
Power cromo satinato  
*Power satin chrome*



**ONV**  
Nickel lucido  
*Polished nickel*



**PGS | forte®**  
Grafite satinato  
*Satin graphite*



**PVD-BG | forte®**  
Oro antico lucido  
*Antique bright gold*



**PVD-SG | forte®**  
Oro antico satinato  
*Antique satin gold*



**PVD-SCB | forte®**  
Rame satinato  
*Satin copper*

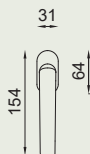
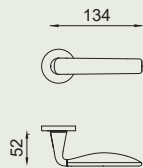

**VIS** VV12

**FINE** VV40

**U** VV80

**VIS** VV22V

**U** VV22TS

**U** VV22U

# Luca Nichetto



Designer originario di Venezia, è attivo a livello internazionale ed è specializzato in design industriale, design del prodotto e consulenza. I suoi due studi si trovano a Venezia – dal 2006 – e in Svezia, a Stoccolma – dal 2011. Ha ricevuto numerosi premi internazionali per i suoi progetti, che spaziano tra prodotti, mobili e accessori, oltre a integrare architettura e design espositivo. Tra i marchi dei suoi progetti, Arflex, Cassina, De La Espada, Foscarini, Hermès, Molteni & C, Tubes, Venini, Wittmann.

*Designer originally from Venice, he works on an international basis and specialises in industrial design, product design and design consultancy. His two studios are based in Italy in Venice – from 2006 – and in Sweden – from 2011. He has been awarded numerous international design awards for his projects, which range across products, furniture and accessories, as well as incorporating architecture and exhibition design. Among the brands of his projects, Arflex, Cassina, De La Espada, Foscarini, Hermès, Molteni & C, Tubes, Venini, Wittmann.*

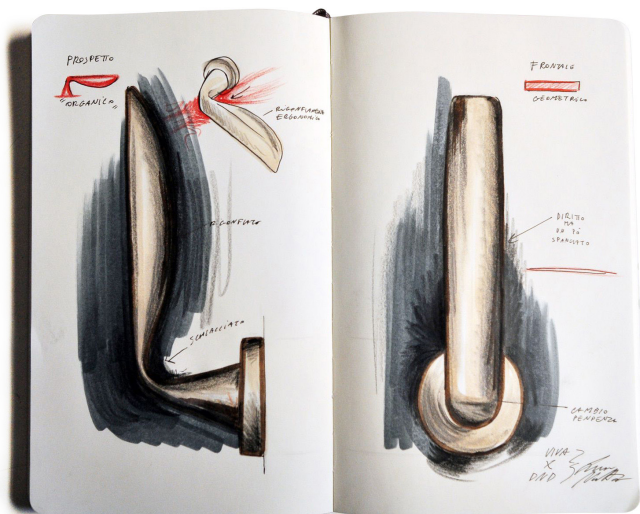

**Vival**  
Disegni della maniglia di /  
Handle sketches by  
Luca Nichetto



Luca Collection, Bernhardt Design (2019)



Fusa, Svenskt Tenn (2019)



Elysia, De La Espada (2014)

# zeppelin





Volumi marcati e arrotondati come rimando formale - e decorativo - ai dirigibili Zeppelin dell'inizio del 1900, per una maniglia contemporanea, dalla sapiente realizzazione tecnica.

*Pronounced rounded volumes as a formal - and decorative - reference to the Zeppelin airships of the early 1900s, for a contemporary handle made with great technical prowess.*

# zeppelin

design:  
**Jaime Hayon**

made in italy



**ZP12**  
ONV

150-

**dnd**22-23



Ottone forgiato  
Forged brass



**ONV**  
Nickel lucido  
*Polished nickel*



**OVE**  
Verde  
*Green*



**ONO**  
Nero  
*Black*



**PGS | forte®**  
Grafite satinato  
*Satin graphite*



**PVD-BG | forte®**  
Oro antico lucido  
*Antique bright gold*



**PVD-SG | forte®**  
Oro antico satinato  
*Antique satin gold*



**PVD-SCB | forte®**  
Rame satinato  
*Satin copper*

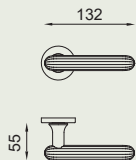

**VIS** ZP12

**U** ZP80

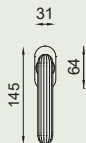

**VIS** ZP22V

**U** ZP22TS

**U** ZP22U

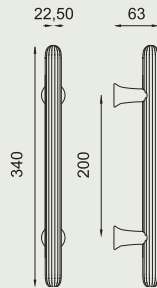

ZP27 singolo

ZP28 set

# Jaime Hayon



Artista-designer originario di Madrid, ha aperto il suo studio a Valencia nel 2010.

Con uffici in Spagna, Italia e Giappone, progetta per Fritz Hansen, Bosa, Cassina, BD Barcelona, Wittmann, Magis, Ceccotti, &Tradition, Baccarat, Paola C, Bisazza, Lladro, Vicarbe, Arflex, Nani Marquina, Vista Alegre, Parachilna.

Ha vinto numerosi premi internazionali ed è stato incluso da Wallpaper Magazine nella lista "Top 100", riconosciuto come uno dei creatori più influenti dell'ultimo decennio.

*Artist-designer originally from Madrid, opened his studio in Valencia in 2010.*

*With offices in Spain, Italy and Japan, he designs for Fritz Hansen, Bosa, Cassina, BD Barcelona, Wittmann, Magis, Ceccotti, &Tradition, Baccarat, Paola C, Bisazza, Lladro, Vicarbe, Arflex, Nani Marquina, Vista Alegre, Parachilna.*

*He has won numerous awards and he has been included by Wallpaper Magazine in its "Top 100" list, recognised by the magazine as one of the most influential creators of the last decade.*

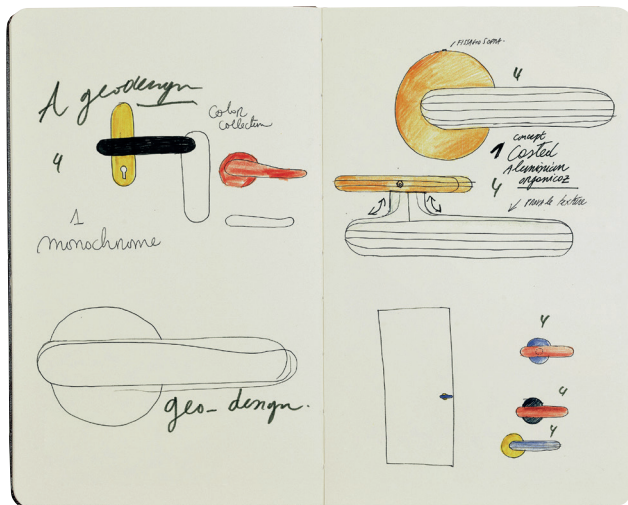

**Zeppelin**  
Disegni della maniglia di /  
Handle sketches by  
Jaime Hayon



La Terraza del Casino, Madrid/Spain (2018)



Camper shop, Tokyo/Japan (2009)



Aballs Lamps, Parachilna (2013)

**madeleine**

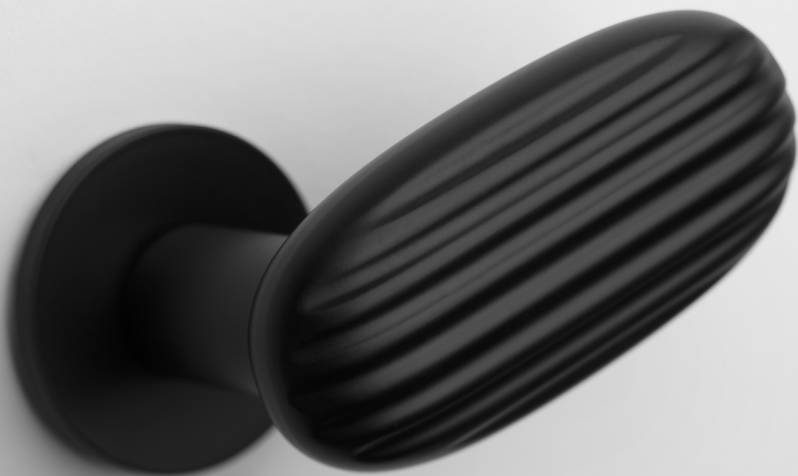



Un omaggio alla dolce  
madeleine d'oltralpe  
in una piccola maniglia  
decorata che ne  
riprende la forma  
a conchiglia.

*A tribute to the  
famous madeleine  
cakes from beyond  
the Alps, in a small  
decorated handle  
that replicates their  
seashell form.*

# madeleine

design:  
Inga Sempé

made in italy



MA40  
PVD-BG | forte®

156-

dnd/22-23

Ottone stampato a caldo  
*Hot stamped brass*



**ONV**  
Nickel lucido  
*Polished nickel*



**ONO**  
Nero  
*Black*



**PGS | forte®**  
Grafite satinato  
*Satin graphite*



**PVD-BG | forte®**  
Oro antico lucido  
*Antique bright gold*



**PVD-SG | forte®**  
Oro antico satinato  
*Antique satin gold*



**PVD-SCB | forte®**  
Rame satinato  
*Satin copper*



**VIS** MA12

**FINE** MA40

**U** MA80

**VIS** MA22V

**U** MA22TS

**U** MA22U

# Inga Sempé



Nata a Parigi, nel 2000 è stata borsista a Villa Medici, presso l'Académie de France di Roma e, nello stesso anno, ha aperto il suo studio parigino. Le sue prime collaborazioni sono state con Edra e Cappellini. Oggi lavora con diverse aziende francesi, scandinave e italiane, tra le quali HAY, Ligne Roset, Wästberg, Magis, Alessi, Luceplan, Mutina, Crane, Rørros, Moustache, Svenskt Tenn, Gärsnäs.

*Born in Paris, she was a fellow at Villa Medici in 2000, at the Académie de France in Rome and opened her Paris studio in the same year. Her first collaborations were with Edra and Cappellini. Today she works with several French, Scandinavian and Italian companies, including HAY, Ligne Roset, Wästberg, Magis, Alessi, Luceplan, Mutina, Crane, Rørros, Moustache, Svenskt Tenn, Gärsnäs.*



Pandarine, Hay (2020)





Lampes, Moustache (2012)



Herringbone, Crane (2017)



w153, Wästberg (2015)

**boole**





Due cilindri si incontrano e si intersecano con il leggero slittamento di uno rispetto all'altro, nella condivisione di una piccola, comune porzione di materia.

*Two cylinders meet and intersect with a slight shift, sharing a small portion of material.*

**boole**

**design:**  
**Odo Fioravanti**

made in italy



**BE40**  
OC

162-

**dnd**22-23

Ottone stampato a caldo  
Hot stamped brass



**OC**  
Power cromo lucido  
*Power polished chrome*



**PCS**  
Power cromo satinato  
*Power satin chrome*



**ONO**  
Nero  
*Black*

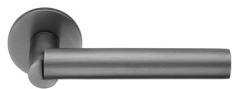

**PGS | forte®**  
Grafite satinato  
*Satin graphite*



**PVD-SG | forte®**  
Oro antico satinato  
*Antique satin gold*

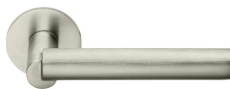

**PVX | forte®**  
Inox satinato  
*Satin steel*

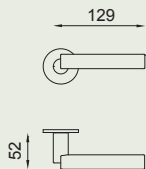

**VIS** BE12

**FINE** BE40

**U** BE80

**VIS** BE22V

**U** BE22TS

**U** BE22U

# Odo Fioravanti



Dal 2003, con base a Milano, lavora come industrial designer sperimentando anche la grafica e l'exhibition design. I suoi oggetti sono stati esposti in molte mostre internazionali e nel 2010 il Design Museum della Triennale di Milano ha dedicato al suo lavoro la personale "Industrious Design". Nel 2011 ha vinto il Compasso d'Oro ADI con la sedia in legno Frida di Pedrali.

Tra i suoi clienti, Alpi, Flou, Fontana Arte, Foscarini, Land Rover, Maison 203, Normann Copenhagen, Pedrali, Toshiba, Vibram, Victorinox.

*Since 2003, based in Milan, he has been working as an industrial designer, while experimenting also with graphic and exhibition design. His objects have been shown in many international exhibitions and in 2010 the Design Museum of the Triennale di Milano dedicated to his work the solo exhibition "Industrious Design". In 2011 he won the Compasso d'Oro ADI award with the Frida wooden chair by Pedrali.*

*Among his clients, Alpi, Flou, Fontana Arte, Foscarini, Land Rover, Maison 203, Normann Copenhagen, Pedrali, Toshiba, Vibram, Victorinox.*

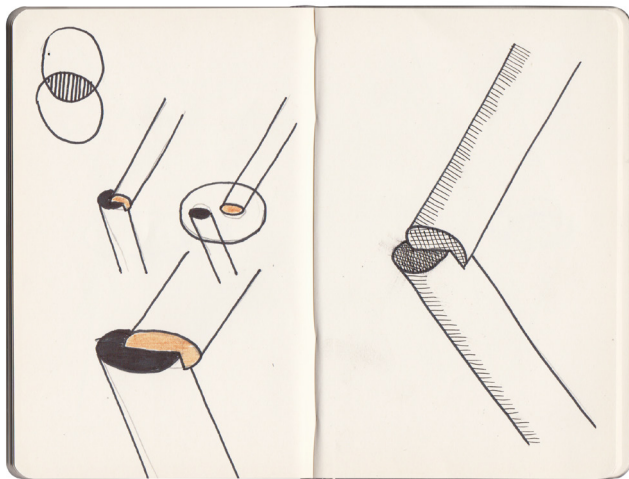

**Boole**  
Disegni della maniglia di /  
Handle sketches by  
Odo Fioravanti



Bern clutch, Maison 203 (2017)



Frida, Pedrali (2008)



Volée, FontanaArte (2016)

**safety**







Un nastro di metallo  
si fa maniglia  
ripiegandosi sul finale,  
per assicurare una  
buona e sicura presa.

*A metal ribbon  
becomes a handle,  
bending at its end  
to provide a sure,  
safe grip.*

**safety**

**design:  
Enrico Martini**

made in italy



**SA40**  
PCS

168-

**dnd**22-23

Ottone stampato a caldo  
*Hot stamped brass*



**PCS**  
Power cromo satinato  
*Power satin chrome*



**ONO**  
Nero  
*Black*

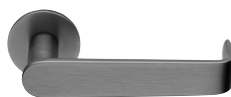

**PGS | forte®**  
Grafite satinato  
*Satin graphite*



**PVD-SG | forte®**  
Oro antico satinato  
*Antique satin gold*



**PVD-SCB | forte®**  
Rame satinato  
*Satin copper*



**PVX | forte®**  
Inox satinato  
*Satin steel*

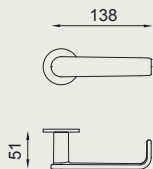

**VIS** SA12

**52** SA16

**FINE** SA40

**VIS** SA22V

**🔒** SA22TS

**iki**





Una costruzione formale palindroma: il profilo della vista superiore è identico a quello della vista frontale, ribaltato di 180 gradi. Una forma elegante ed essenziale, un volume mutevole che suggerisce all'utente la presa con il suo profilo frontale.

*A palindromic structural form: the profile in the view from above is identical to that of the frontal view, but reversed by 180 degrees. An elegant and essential form, a mutable volume that suggests the proper grip with its frontal profile.*

**iki**

**design:**  
**Mario Sciarato**  
**Alessandro Stabile**

made in italy

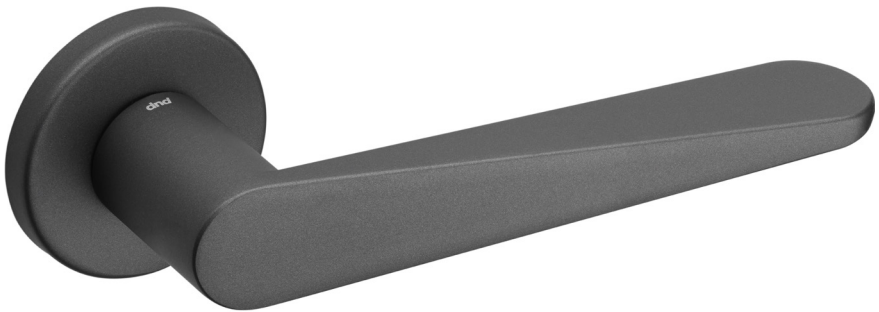

**IK12**  
ZAN

172-

**dnd**22-23

Zama  
Zamak



**ZCS**  
Cromo satinato  
Satin chrome



**ZNE**  
Nero  
Black



**ZAN**  
Antracite  
Anthracite

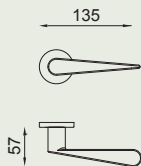

**VIS** IK12

**FINE** IK40

**U** IK80

**VIS** IK22V

**U** IK22TS

**U** IK22U

# Mario Scairato



Vive e lavora tra Milano e Paestum, la città da cui proviene. Si è laureato in Industrial Design allo IUAV / Università della Repubblica di San Marino nel 2011 e dal 2015 ha disegnato per diversi marchi, tra cui Alessi, Internoitaliano e Moleskine. Dal 2015 è art director di Paestum Experience, un progetto di branding da lui fondato che mira alla promozione e alla comunicazione della città di Capaccio Paestum.

*He lives and works between Milan and Paestum, his hometown. He graduated in Industrial Design at the IUAV / Università della Repubblica di San Marino in 2011. Since 2015 he has designed for some brands including Alessi, Internoitaliano and Moleskine.*

*He has been art director of Paestum Experience since 2015, a branding project he founded that aims to promote and communicate the city of Capaccio Paestum.*

# Alessandro Stabile



Originario di Milano, è uno dei dieci "Top Young Italian Industrial Designers" selezionati dall'Istituto Italiano di Cultura di New York nel 2013.

Nel 2011 ha fondato il suo studio ed è specializzato in product design e direzione artistica.

Nel 2016 due suoi progetti hanno vinto il primo e il secondo premio Young&Design come i due migliori prodotti presentati alla Milano Design Week da un under 35. Disegna per diversi brand tra cui Moleskine, Alessi, Ferrero Nutella.

*Originally from Milan, he is one of the ten "Top Young Italian Industrial Designers" selected by the Italian Cultural Institute in New York in 2013.*

*In 2011 he founded his design studio specialising in product design and artistic direction.*

*In 2016 two of his ideas won the first and the second prizes of the Young&Design Award, as the best projects of Milan Design Week from an under 35. He designs for different brands such as Moleskine, Alessi, Ferrero Nutella.*





Scairato: Cave + Gioi, Internoitaliano (2017)  
 Stabile: Hard luggage, Moleskine (2019)  
 Scairato+Stabile: Pen + Ellipse, Moleskine (2018)

IKI  
 Disegni della  
 maniglia di /  
 Handle sketches by  
 Mario Scairato+  
 Alessandro Stabile

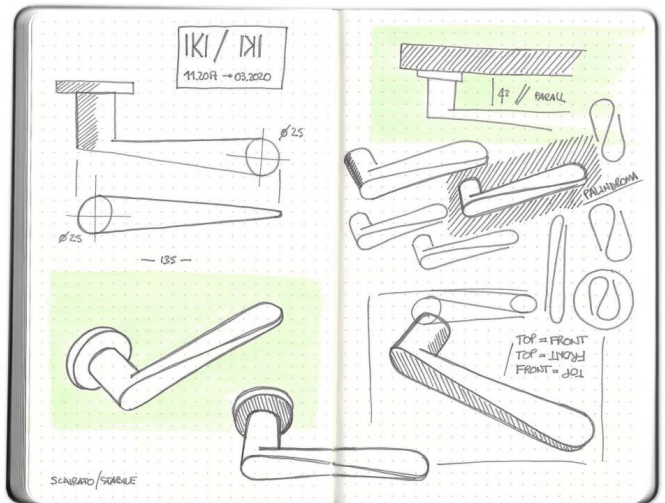

# **ginkgo**





Una forma di ispirazione naturale, quale la bellissima foglia del Ginkgo, si fa struttura e decoro per una maniglia che nasce in due diverse versioni.

*A form based on nature, the special, unique shape of a Ginkgo leaf, becomes the structure and decoration of a handle that is made in two different versions.*

**ginkgo**

**design:**  
**Giulio lacchetti**

made in italy

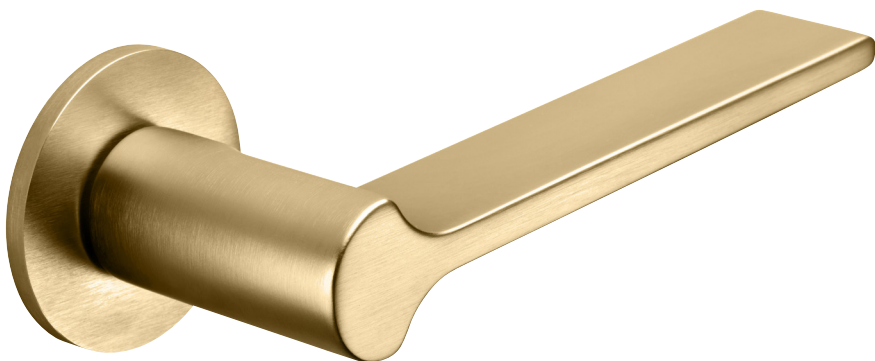

**GK40**  
PVD-SG | forte®

178-

**dnd**22-23

Ottone stampato a caldo  
Hot stamped brass



**OC**  
Power cromo lucido  
Power polished chrome



**PCS**  
Power cromo satinato  
Power satin chrome



**ONV**  
Nickel lucido  
Polished nickel



**ONO**  
Nero  
Black



**PGS | forte®**  
Grafito satinato  
Satin graphite



**PVD-BG | forte®**  
Oro antico lucido  
Antique bright gold



**PVD-SG | forte®**  
Oro antico satinato  
Antique satin gold



**Good Design Awards  
2017**

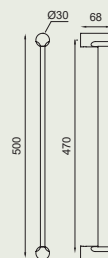
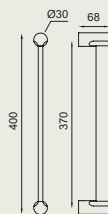
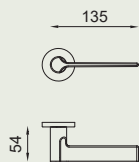

**VIS** GK12

**VIS** GK22V

**FINE** GK40

**U** GK22TS

GK27 - singolo

GK29 - singolo

**U** GK80

**U** GK22U

GK28 - set

GK30 - set

# **ginkgo biloba**



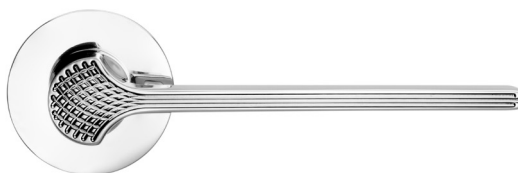

Ginkgo Biloba, la versione della maniglia Ginkgo con l'incisione in superficie, è un ulteriore rimando metaforico alle venature della foglia.

*Ginkgo Biloba, the version of the Ginkgo handle with the decorative surface engraving, is a further metaphorical reminder of the veins of the leaf.*

# ginkgo biloba

design:  
**Giulio lacchetti**

made in italy

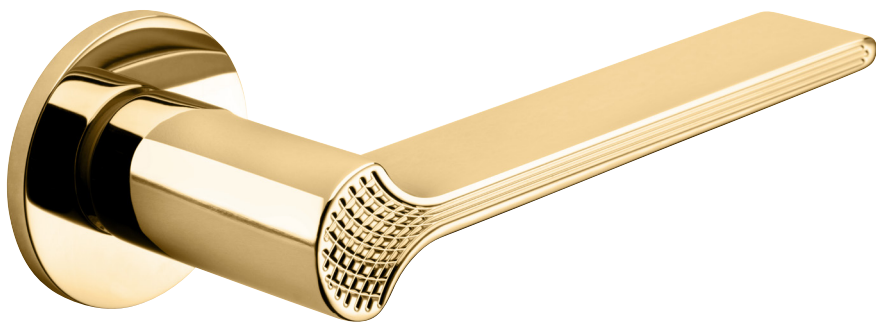

**GB40**  
PVD-BG | forte®

182-

**dnd**22-23



Ottone stampato a caldo  
Hot stamped brass



**OC**  
Power cromo lucido  
Power polished chrome



**PCS**  
Power cromo satinato  
Power satin chrome



**ONV**  
Nickel lucido  
Polished nickel



**ONO**  
Nero  
Black



**PGS | forte®**  
Grafite satinato  
Satin graphite



**PVD-BG | forte®**  
Oro antico lucido  
Antique bright gold



**PVD-SG | forte®**  
Oro antico satinato  
Antique satin gold



**Good Design Awards  
2017**

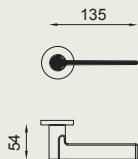

**VIS** GB12

**FINE** GB40

**U** GB80



**VIS** GB22V

**LOCK** GB22TS

**U** GB22U

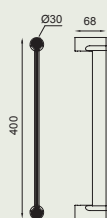

GB27 - singolo

GB28 - set

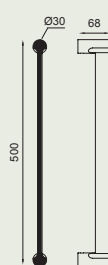

GB29 - singolo

GB30 - set

# timeless



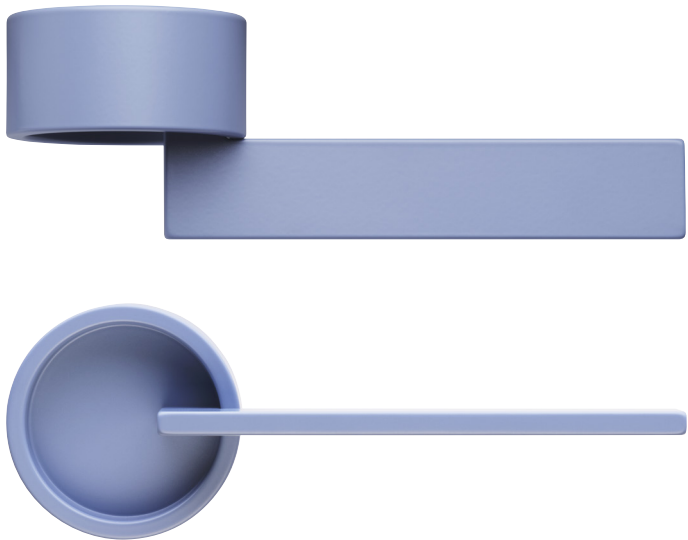

Due segni grafici  
essenziali, una linea  
e un cerchio che  
si intersecano in  
maniera centrale e  
simmetrica.

*Two essential graphic  
signs, a line and  
a circle that intersect  
in a central and  
symmetrical way.*

**timeless**

**design:**  
**Marco Pisati**

made in italy

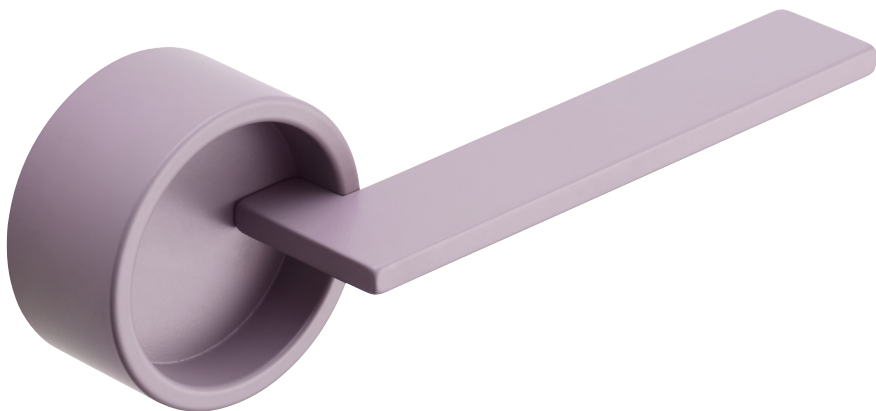

**TL01**  
AVP

186-

**dnd**22-23

Alluminio  
Aluminium



**ASV**  
Silver  
Silver



**ARO**  
Oro satinato  
Satin gold



**ABR**  
Bronzo  
Bronze



**ABN**  
Bianco  
White



**ANE**  
Nero  
Black



**ABT new**  
Turchese  
Turquoise



**AGO new**  
Giallo oliva  
Yellow olive



**AVP new**  
Violetto pastello  
Pastel violet



**ABC new**  
Blu colomba  
Blue dove

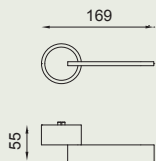

**FINE** TL01



Pomolo  
Knob

**FINE** TL40 - set  
TL39 - singolo



Pomolino per mobili  
Knob furniture

**FINE** TL70

**isabella**



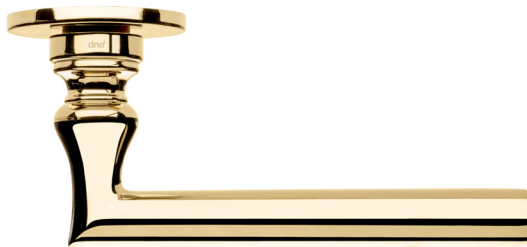

Un cilindro e lievi  
modanature, tra forme  
classiche e volumi  
moderni.

*A cylinder and slight  
moldings, between  
classical forms and  
modern volumes.*

# isabella

design:  
**Marco Pisati**

made in italy



IS13  
OC

190-

dnd/22-23



Ottone stampato a caldo  
Hot stamped brass



**OGH**  
Bronzo satinato opaco  
*Matt satin bronze*



**OC**  
Power cromo lucido  
*Power polished chrome*



**ONV**  
Nickel lucido  
*Polished nickel*



**PGS | forte®**  
Grafite satinato  
*Satin graphite*



**PVD-BG | forte®**  
Oro antico lucido  
*Antique bright gold*



**PVD-SG | forte®**  
Oro antico satinato  
*Antique satin gold*

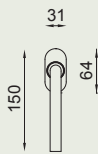
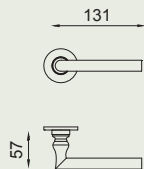

- R** IS13
- FINE** IS40
- U** IS80

- VIS** IS22V
- U** IS22TS
- U** IS22U

# lucrezia





Rimandi rinascimentali nel bel modellato dello stelo, a cui si aggiunge il disegno dell'impugnatura: una forma rettangolare alleggerita da un'elegante modanatura a caratterizzarne il bordo.

*Renaissance references in the fine shaping of the stem, joined by the design of the grip: a rectangular form lightened by elegant shaped borders.*

# lucrezia

design:  
**Marco Pisati**

made in italy



**LT13**  
PVD-BG | forte®

Ottone forgiato  
*Forged brass*



**OGH**  
 Bronzo satinato opaco  
*Matt satin bronze*



**ONV**  
 Nickel lucido  
*Polished nickel*



**PGS | forte®**  
 Grafite satinato  
*Satin graphite*



**PVD-BG | forte®**  
 Oro antico lucido  
*Antique bright gold*



**PVD-SG | forte®**  
 Oro antico satinato  
*Antique satin gold*

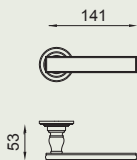

**FINE** LT40

**R** LT13



**VIS** LT30V

**LOCK** LT30TS

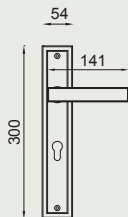

LT10

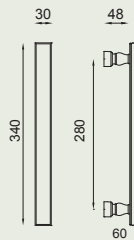

LT27\*

\* Altre misure disponibili  
 su richiesta.  
*Other lengths available  
 on request.*

# lucrezia 02

design:  
Marco Pisati

made in italy



LT41  
ONV

196-

dnd/22-23

Ottone forgiato  
*Forged brass*



**OGH**  
Bronzo satinato opaco  
*Matt satin bronze*



**ONV**  
Nickel lucido  
*Polished nickel*



**PGS | forte®**  
Grafite satinato  
*Satin graphite*



**PVD-BG | forte®**  
Oro antico lucido  
*Antique bright gold*



**PVD-SG | forte®**  
Oro antico satinato  
*Antique satin gold*

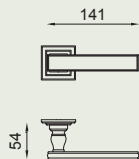

**FINE** LT41

**R** LT14



**VIS** LT31V

**🔒** LT31TS

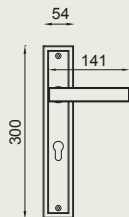

LT10

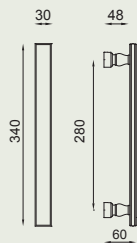

LT27 \*

\* Altre misure disponibili  
su richiesta.  
*Other lengths available  
on request.*

# **ginevra**

**design: Dnd  
technical division**

made in italy

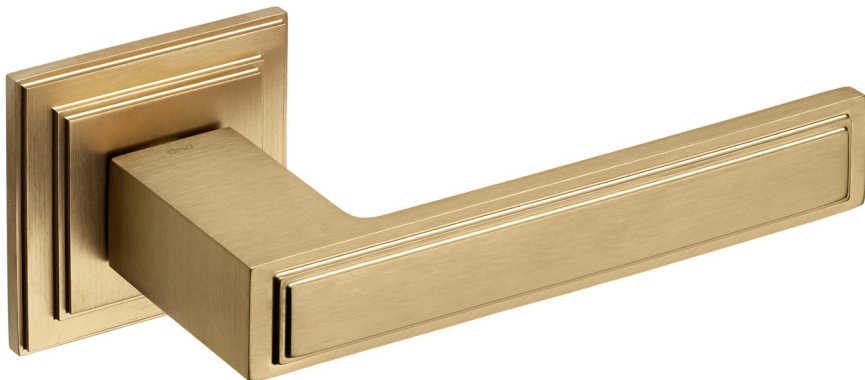

**G19**  
PVD-SG | forte®

198-

**dnd**22-23



Ottone forgiato  
*Forged brass*



**OGH**  
Bronzo satinato opaco  
*Matt satin bronze*



**ONV**  
Nickel lucido  
*Polished nickel*



**PGS | forte®**  
Grafite satinato  
*Satin graphite*



**PVD-BG | forte®**  
Oro antico lucido  
*Antique bright gold*



**PVD-SG | forte®**  
Oro antico satinato  
*Antique satin gold*

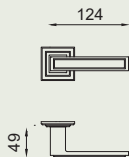

**R** GI19

**FINE** GI41

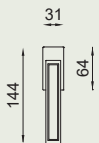

**R** GI22V

**🔒** GI22TS

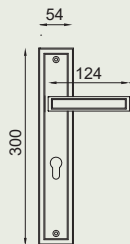

GI10

# C-1918





Una maniglia – e una serie – d'autore caratterizzata dalla sapiente unione di acciaio e rame. Un progetto inedito, riscoperto e prodotto da Dnd con grande orgoglio.

*A signature handle – and series – based on the felicitous combination of steel and copper. An original project, rediscovered and produced with great pride by Dnd.*

# C-1918

design:  
**Achille Castiglioni**  
**Gianfranco Cavaglia**

made in italy



**CC12**  
L316 + R

202-

**dnd**22-23

Acciaio inox AISI 316 + rame  
*AISI Stainless steel 316 + copper*



**S316 + R**  
 AISI 316 satinato  
 + inserto rame PVD  
*AISI 316 satin*  
 + PVD copper insert

**L316 + R**  
 AISI 316 lucido  
 + inserto rame PVD  
*AISI 316 polished*  
 + PVD copper insert



**S316 + N**  
 AISI 316 satinato  
 + inserto rame nero  
*AISI 316 satin*  
 + copper black insert

**L316 + N**  
 AISI 316 lucido  
 + inserto rame nero  
*AISI 316 polished*  
 + copper black insert

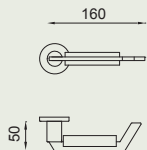

**VIS** CC12

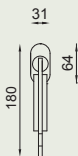

CC22

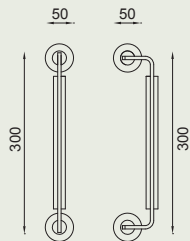

CC25

CC27

# intake





Disegnata per il Museo Casa Enzo Ferrari di Modena, solida nella materia e plastica nella forma, è un omaggio al car design più attento.

*Designed for the Enzo Ferrari Museum in Modena, solid in terms of material, sculptural in terms of form, in a tribute to the finest automotive design.*

# intake

design:  
**Andrea Morgante**

made in italy



**IN14**  
ONO

206-

**dnd**22-23



Ottone stampato a caldo  
*Hot stamped brass*



**OC**  
Power cromo lucido  
*Power polished chrome*



**OBN**  
Bianco  
*White*



**ONO**  
Nero  
*Black*

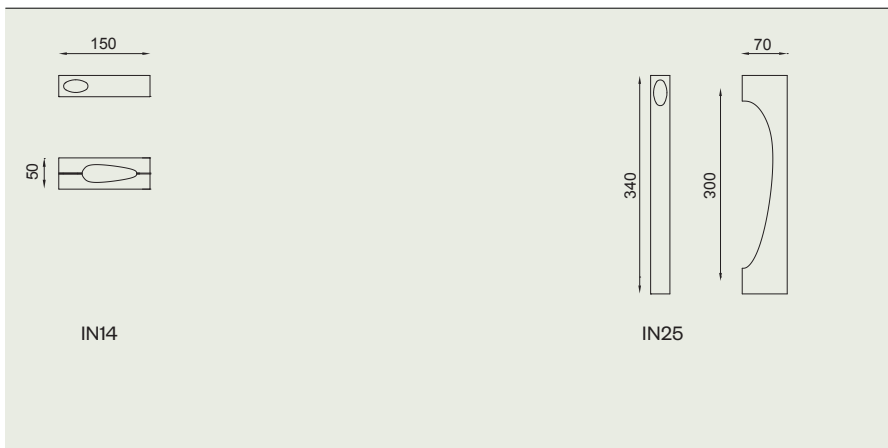

**luxury**

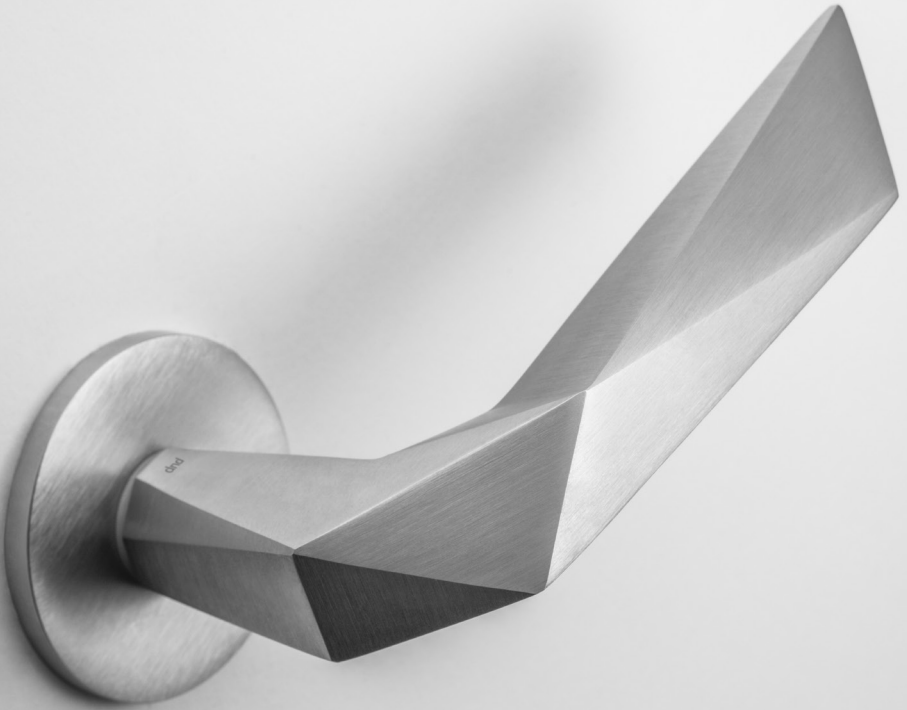

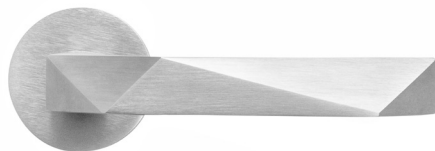

Geometrie sfaccettate e tagli netti nella materia rimandano a celebri episodi dell'architettura contemporanea.

*Faceted geometry and clean cuts in the material evoke famous episodes of contemporary architecture.*

# luxury

design:  
**Mauro Ronchi**

made in italy

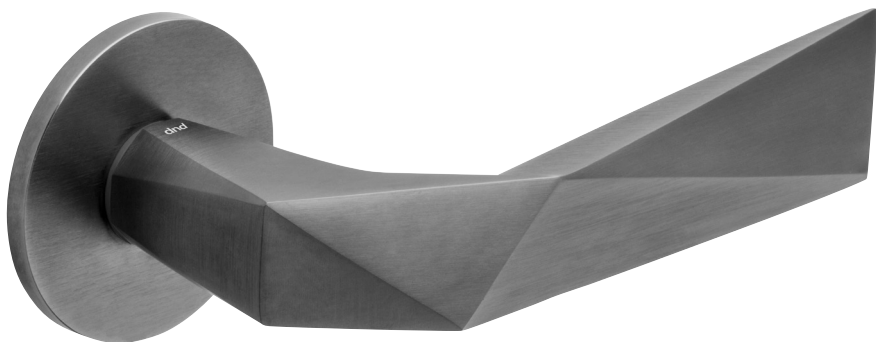

**LU40**  
PGS|forte®

210-

**dnd**22-23

Ottone stampato a caldo  
Hot stamped brass



**OGH**  
Bronzo satinato opaco  
*Matt satin bronze*



**OC**  
Power cromo lucido  
*Power polished chrome*



**PCS**  
Power cromo satinato  
*Power satin chrome*



**ONO**  
Nero  
*Black*



**PGS | forte®**  
Grafite satinato  
*Satin graphite*



**PVD-BG | forte®**  
Oro antico lucido  
*Antique bright gold*



**PVD-SG | forte®**  
Oro antico satinato  
*Antique satin gold*



**PVD-SCB | forte®**  
Rame satinato  
*Satin copper*

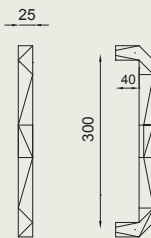
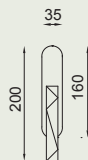
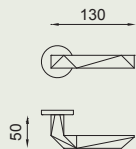

**VIS** LU12

**52** LU16

**FINE** LU40

**U** LU80

**VIS** LU22V

**U** LU22TS

**U** LU22U

LU20C

LU21M

LU27

# luxury 02

design:  
**Mauro Ronchi**

made in italy

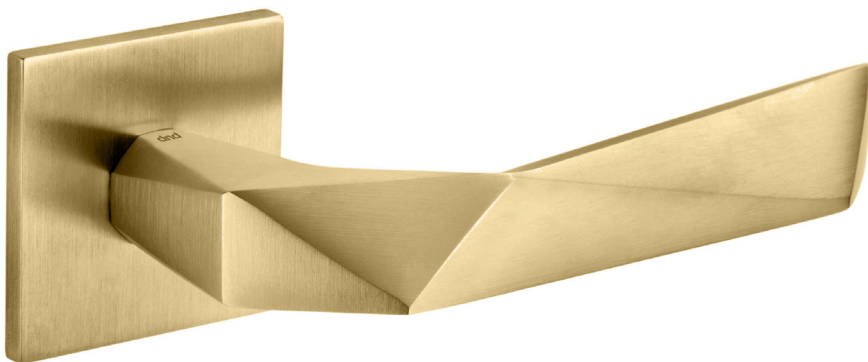

**LU41**  
PVD-SG | forte®

212-

**dnd**22-23

Ottone stampato a caldo  
Hot stamped brass



**OGH**  
Bronzo satinato opaco  
Matt satin bronze



**OC**  
Power cromo lucido  
Power polished chrome



**PCS**  
Power cromo satinato  
Power satin chrome



**ONO**  
Nero  
Black

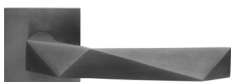

**PGS | forte®**  
Grafite satinato  
Satin graphite



**PVD-BG | forte®**  
Oro antico lucido  
Antique bright gold



**PVD-SG | forte®**  
Oro antico satinato  
Antique satin gold



**PVD-SCB | forte®**  
Rame satinato  
Satin copper

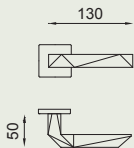

**VIS** LU14

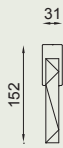

**R** LU25

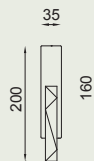

LU23C

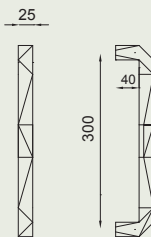

LU27

**FINE** LU41

**VIS** LU25V

LU24M

**52** LU18

**🔒** LU25TS

**aretè**





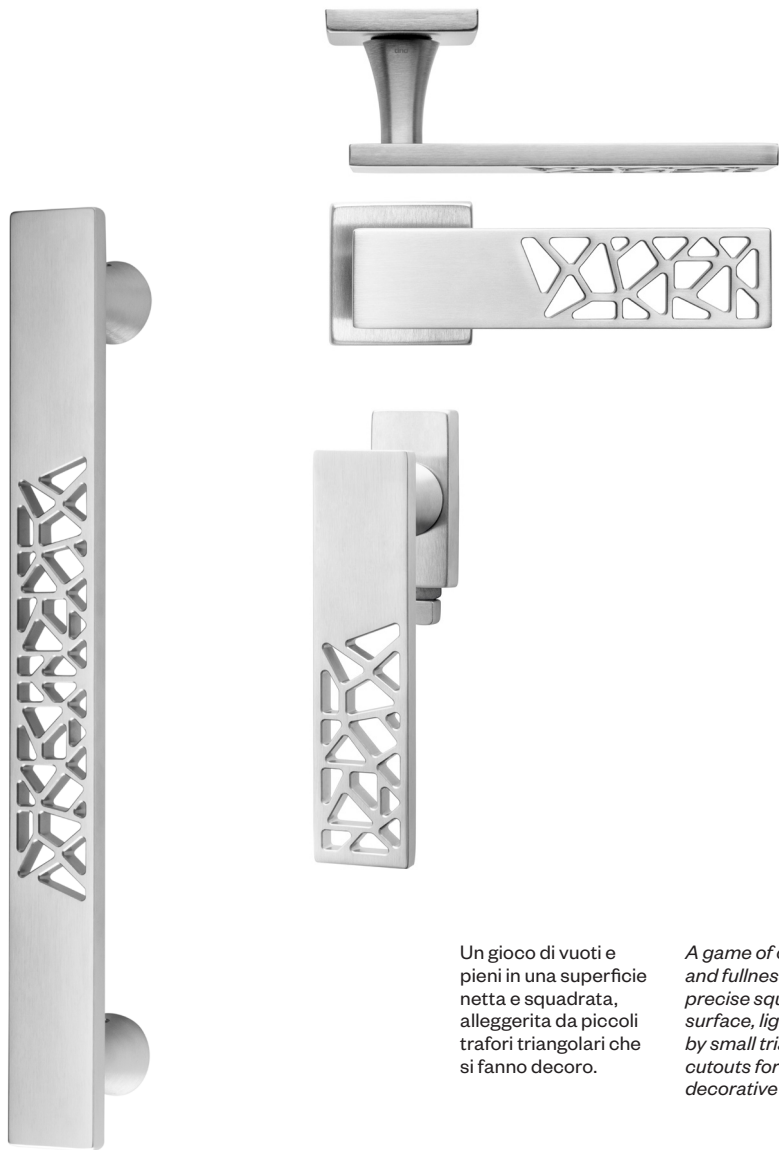

Un gioco di vuoti e pieni in una superficie netta e squadrata, alleggerita da piccoli trafori triangolari che si fanno decoro.

*A game of openness and fullness in a precise squared surface, lightened by small triangular cutouts for a decorative touch.*

# aretè

design:  
**Mauro Ronchi**

made in italy

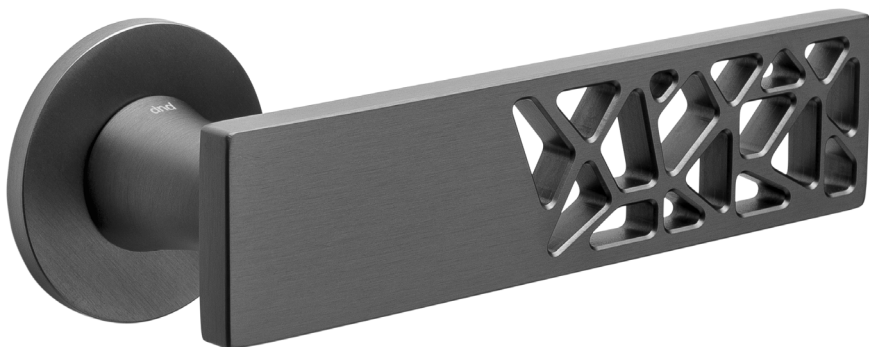

**AT40**  
PGS|forte®

216-

**dnd**22-23

Ottone forgiato  
*Forged brass*



**AB**  
Bronzato  
*Antique bronze*



**OGH**  
Bronzo satinato opaco  
*Matt satin bronze*



**OC**  
Power cromo lucido  
*Power polished chrome*



**PCS**  
Power cromo satinato  
*Power satin chrome*



**PGS | forte®**  
Grafito satinato  
*Satin graphite*



**PVD-SG | forte®**  
Oro antico satinato  
*Antique satin gold*



**PVX | forte®**  
Inox satinato  
*Satin steel*

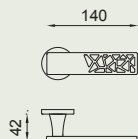

**VIS** AT12

**FINE** AT40

**62** AT16

**U** AT80

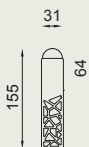

**VIS** AT22V

**U** AT22TS

**U** AT22U

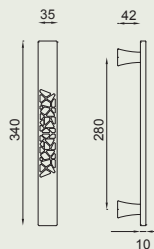

AT27 \* - singolo  
AT28 \* - set

\* Altre misure disponibili  
su richiesta.  
*Other lengths available  
on request.*

# aretè 02

design:  
**Mauro Ronchi**

made in italy



AT41  
OC

218-

dnd/22-23

Ottone forgiato  
*Forged brass*



**AB**  
Bronzato  
*Antique bronze*



**OGH**  
Bronzo satinato opaco  
*Matt satin bronze*



**OC**  
Power cromo lucido  
*Power polished chrome*



**PCS**  
Power cromo satinato  
*Power satin chrome*



**PGS | forte®**  
Grafite satinato  
*Satin graphite*



**PVD-SG | forte®**  
Oro antico satinato  
*Antique satin gold*



**PVX | forte®**  
Inox satinato  
*Satin steel*

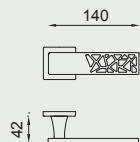

**VIS** AT14

**FINE** AT41

**52** AT18

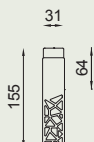

**R** AT25

**VIS** AT25V

**🔒** AT25TS

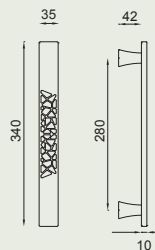

AT27\* - singolo

AT28\* - set

\* Altre misure disponibili  
su richiesta.  
*Other lengths available  
on request.*

# aretè L





Il nitore di una geometria classica dal sapore contemporaneo: una maniglia che parla di sofisticata semplicità.

*The clarity of classical geometry with a contemporary mood: a handle that speaks of sophisticated simplicity.*

# aretè L

design:  
**Mauro Ronchi**

made in italy



**AL40**  
OGH

222-

**dnd**22-23



Ottone forgiato  
*Forged brass*



**AB**  
Bronzato  
*Antique bronze*



**OGH**  
Bronzo satinato opaco  
*Matt satin bronze*



**OC**  
Power cromo lucido  
*Power polished chrome*



**PCS**  
Power cromo satinato  
*Power satin chrome*



**PGS | forte®**  
Grafite satinato  
*Satin graphite*



**PVD-SG | forte®**  
Oro antico satinato  
*Antique satin gold*



**PVX | forte®**  
Inox satinato  
*Satin steel*

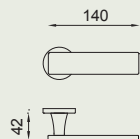

**VIS** AL12

**52** AL16

**FINE** AL40

**U** AL80

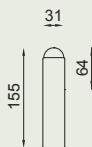

**VIS** AL22V

**U** AL22TS

**U** AL22U

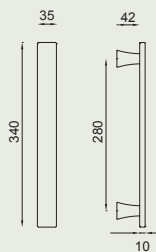

AL27\* - singolo  
AL28\* - set

\* Altre misure disponibili  
su richiesta.  
*Other lengths available  
on request.*

# aretè L 02

design:  
**Mauro Ronchi**

made in italy

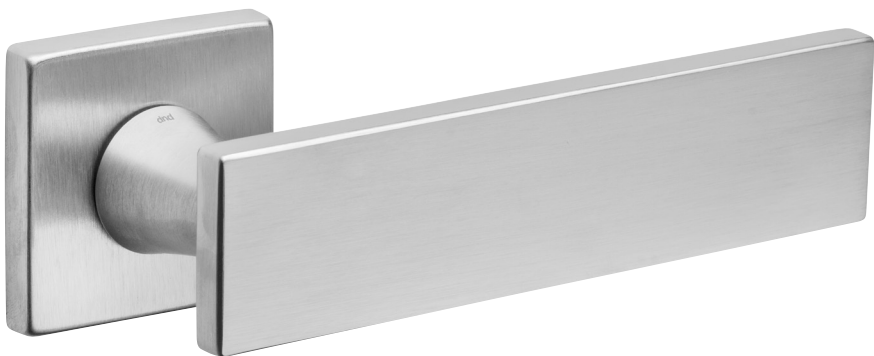

**AL14**  
PCS

224-

**dnd**22-23

Ottone forgiato  
*Forged brass*



**AB**  
Bronzato  
*Antique bronze*



**OGH**  
Bronzo satinato opaco  
*Matt satin bronze*



**OC**  
Power cromo lucido  
*Power polished chrome*



**PCS**  
Power cromo satinato  
*Power satin chrome*



**PGS | forte®**  
Grafito satinato  
*Satin graphite*



**PVD-SG | forte®**  
Oro antico satinato  
*Antique satin gold*



**PVX | forte®**  
Inox satinato  
*Satin steel*

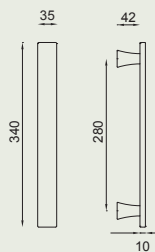
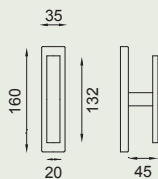
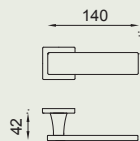

**VIS** AL14

**R** AL25

ED26C

AL27\* - singolo

**FINE** AL41

**VIS** AL25V

ED26M

AL28\* - set

**52** AL18

**🔒** AL25TS

\* Altre misure disponibili  
su richiesta.  
*Other lengths available  
on request.*

**cloe**



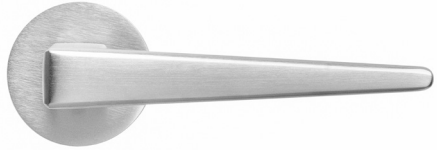
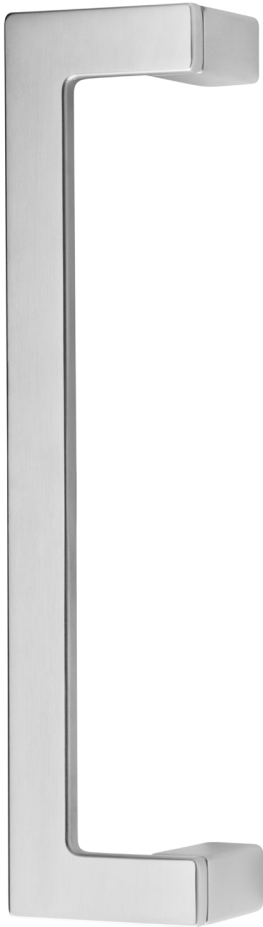

Un triangolo scolpito e rigoroso, geometrie nitide per una maniglia dedicata ad ambienti minimali ed essenziali.

*A rigorously sculpted triangle, a clear geometric form in a handle designed for essential, minimal spaces.*

**cloe**

**design: Dnd  
technical division**

made in italy



**CL40**  
PGS|forte®

228-

**dnd**22-23

Ottone stampato a caldo  
Hot stamped brass



**OC**  
Power cromo lucido  
*Power polished chrome*



**PCS**  
Power cromo satinato  
*Power satin chrome*



**PGS | forte®**  
Grafite satinato  
*Satin graphite*



**PVD-BG | forte®**  
Oro antico lucido  
*Antique bright gold*



**PVD-SG | forte®**  
Oro antico satinato  
*Antique satin gold*

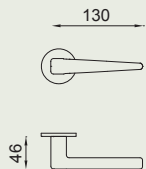

**VIS** CL12

**FINE** CL40

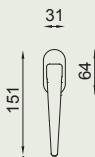

**VIS** CL22V

**🔒** CL22TS



CL27 - 300 mm

CL29 - 500 mm

# cloe 02

design: Dnd  
technical division

made in italy

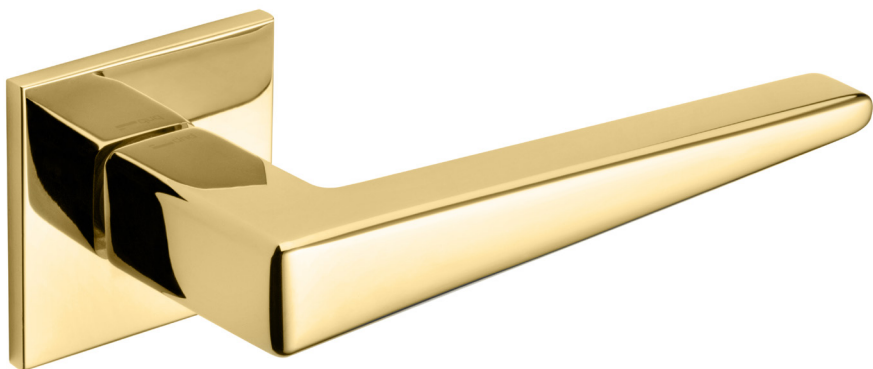

CL41  
PVD-BG | forte®

230-

dnd/22-23



Ottone stampato a caldo  
Hot stamped brass



**OC**  
Power cromo lucido  
*Power polished chrome*



**PCS**  
Power cromo satinato  
*Power satin chrome*



**PGS | forte®**  
Grafite satinato  
*Satin graphite*



**PVD-BG | forte®**  
Oro antico lucido  
*Antique bright gold*



**PVD-SG | forte®**  
Oro antico satinato  
*Antique satin gold*

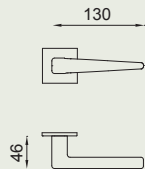

**VIS** CL14

**FINE** CL41

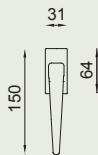

**VIS** CL25V

**🔒** CL25TS

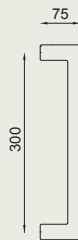

CL27 - 300 mm

CL29 - 500 mm

# change B 02

design:  
**Sandro Santantonio**

made in italy

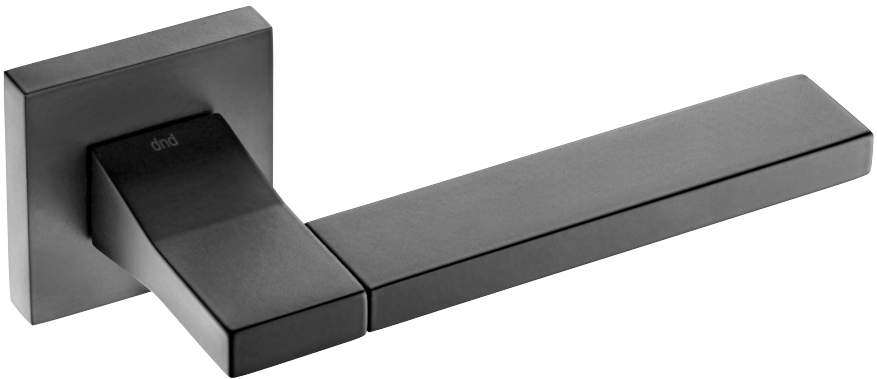

**CB18**  
ONO

232-

**dnd**22-23

Ottone stampato a caldo  
*Hot stamped brass*



**PCS new**  
Power cromo satinato  
*Power satin chrome*



**CCS**  
Cromo - Power cromo satinato  
*Chrome - Power satin chrome*



**OBN**  
Bianco  
*White*



**ONO**  
Nero  
*Black*



**V702**  
Marrone scuro  
*Dark brown*

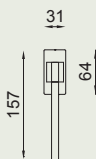
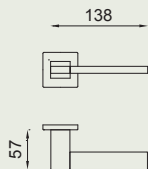

**VIS** CB14

**52** CB18

**S** CB63

**R** CB25

**🔒** CB25TS

# edra 02



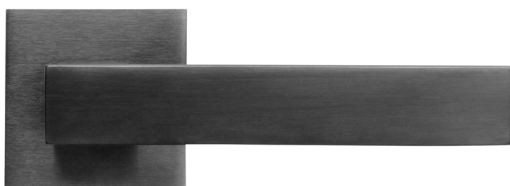

La forza di una forma  
archetipica: l'idea  
stessa di maniglia  
si concretizza in  
geometrie e volumi di  
essenziale purezza.

*The force of  
archetypal form: the  
idea of the handle  
itself embodied by  
geometric lines and  
volumes of essential  
purity.*

# edra 02

design:  
**Mauro Ronchi**

made in italy

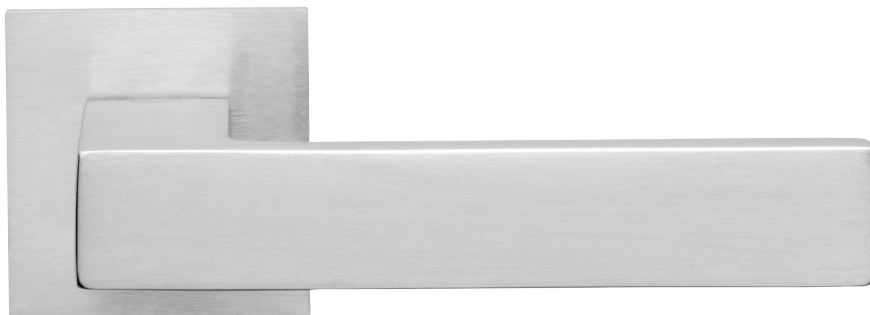

**ED41**  
PCS

236-

**dnd**22-23

Ottone stampato a caldo  
Hot stamped brass



**OGH**  
Bronzo satinato opaco  
Matt satin bronze



**OC**  
Power cromo lucido  
Power polished chrome



**PCS**  
Power cromo satinato  
Power satin chrome



**ONO**  
Nero  
Black



**ONS**  
Nickel satinato  
Satin nickel



**PGS | forte®**  
Grafite satinato  
Satin graphite



**PVX | forte®**  
Inox satinato  
Satin steel



**PVD-SG | forte®**  
Oro antico satinato  
Antique satin gold



**PVD-SCB | forte®**  
Rame satinato  
Satin copper

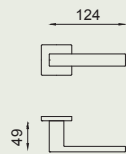

**VIS** ED14

**FINE** ED41

**52** ED18

**R** ED63



**R** ED25

**VIS** ED25V

**🔒** ED25TS

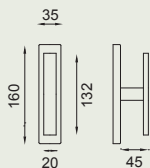

ED26C

ED26M

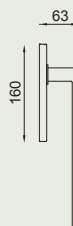

ED60



L025

**fluke**







Una forma dinamica che nasce dall'incontro di due volumi troncoconici contrapposti: il segno forte di un design riconoscibile e riconosciuto.

*A dynamic form that arises from the meeting of two opposing cones: the vivid impact of a recognizable design.*

**fluke**

**design:**  
**Karim Rashid**

made in italy



**FK14**  
PCS

240-

**dnd**22-23

Ottone stampato a caldo  
*Hot stamped brass*



**OC**  
Power cromo lucido  
*Power polished chrome*



**PCS**  
Power cromo satinato  
*Power satin chrome*

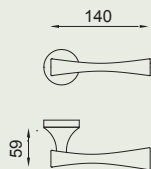

**FINE** FK40

**R** FK14

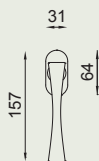

**VIS** FK22V

**LOCK** FK22TS

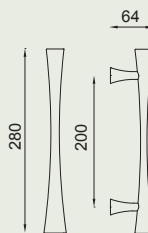

FK27

# luce P NEW





Una leva dalle geometrie solide e pulite, disegnate e costruite con attenzione intorno a un angolo di 90 gradi. Presa ergonomica e appeal contemporaneo, con la luce che enfatizza i profili.

*A lever with solid, clean geometries, carefully designed and constructed around a 90-degree angle. Ergonomic grip and contemporary appeal, with light emphasising the profiles.*

# luce P

**design:**  
**Dnd technical**  
**division**

made in italy



**LP12**  
**ZOS**

244-

**dnd**22-23



**ZOS**  
Ottonato satinato  
*Satin brass color*



**ZGH**  
Bronzo satinato opaco  
*Matt satin bronze*



**ZC**  
Cromo lucido  
*Polished chrome*



**ZCS**  
Cromo satinato  
*Satin chrome*



**ZNS**  
Nickel satinato  
*Satin nickel*



**ZNE**  
Nero  
*Black*



**ZBN**  
Bianco  
*White*



**ZAN**  
Antracite  
*Anthracite*

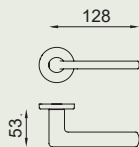

**VIS** LP12

**FINE** LP40

**S** LP62

**U** LP80

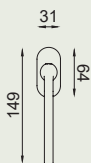

**VIS** LP22V

**U** LP22TS

**U** LP22U

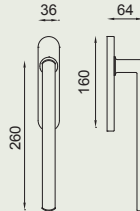

LC50



LC26 - singolo

LC28 - set

# luce P 02

design:  
Dnd technical  
division

made in italy



LP14  
ZNE

246-

dnd/22-23





**ZOS**  
Ottonato satinato  
*Satin brass color*



**ZGH**  
Bronzo satinato opaco  
*Matt satin bronze*



**ZC**  
Cromo lucido  
*Polished chrome*



**ZCS**  
Cromo satinato  
*Satin chrome*



**ZNS**  
Nickel satinato  
*Satin nickel*



**ZNE**  
Nero  
*Black*



**ZBN**  
Bianco  
*White*



**ZAN**  
Antracite  
*Anthracite*

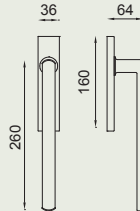
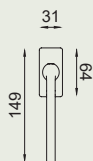
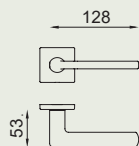

**VIS** LP14

**VIS** LP25V

LC60

LC26 - singolo

**FINE** LP41

 LP25TS

LC28 - set

**S** LP63

# luce



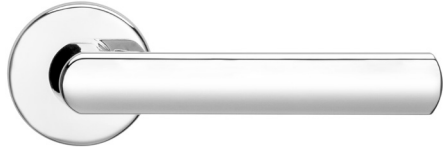
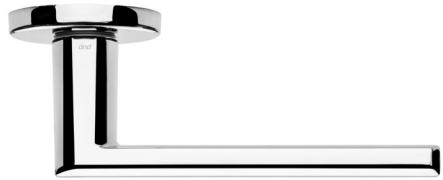

La maniglia come fatto scultoreo, dove la luce evidenzia morbidezza e taglia i volumi in modo netto per restituirci l'idea stessa di un concetto plastico fuori dal tempo.

*The handle as sculpture, where light brings out softness and volumes with clarity, conveying the idea of a timeless shaped object.*

# luce

**design: Dnd  
technical division**

made in italy



**LC12**  
ZNE

250-

**dnd**22-23

Zama  
Zamak



**ZOS**  
Ottonato satinato  
*Satin brass color*



**ZGH**  
Bronzo satinato opaco  
*Matt satin bronze*



**ZC**  
Cromo lucido  
*Polished chrome*



**ZNS**  
Nickel satinato  
*Satin nickel*



**ZCS**  
Cromo satinato  
*Satin chrome*



**ZNE**  
Nero  
*Black*



**ZBN**  
Bianco  
*White*



**ZAN**  
Antracite  
*Anthracite*

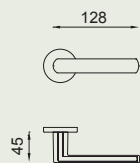

**VIS** LC12

**FINE** LC40

**S** LC62

**U** LC80



**VIS** LC30V

**LC30TS**

**U** LC30U

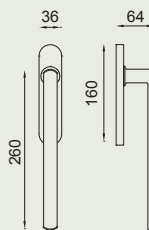

LC50



LC26 - singolo

LC28 - set

# luce 02

design: Dnd  
technical division

made in italy

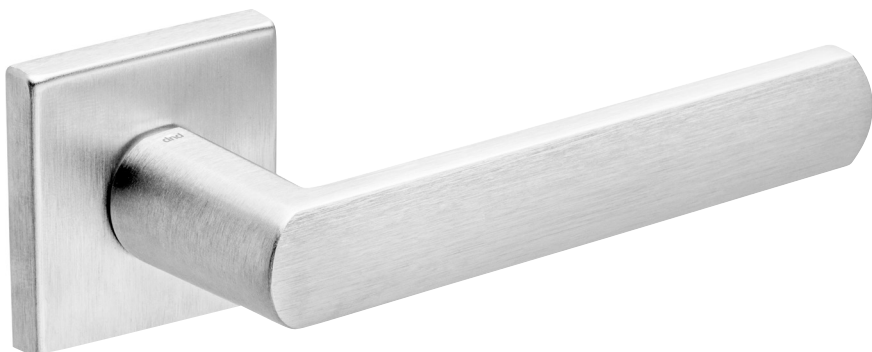

LC14  
ZOS

252-

dnd/22-23

Zama  
Zamak



**ZOS**  
Ottonato satinato  
*Satin brass color*



**ZGH**  
Bronzo satinato opaco  
*Matt satin bronze*



**ZC**  
Cromo lucido  
*Polished chrome*



**ZNS**  
Nickel satinato  
*Satin nickel*



**ZCS**  
Cromo satinato  
*Satin chrome*



**ZNE**  
Nero  
*Black*



**ZBN**  
Bianco  
*White*



**ZAN**  
Antracite  
*Anthracite*

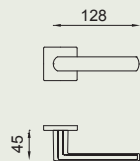

**VIS** LC14

**FINE** LC41

**S** LC63

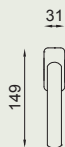

**VIS** LC31V

**LC** LC31TS

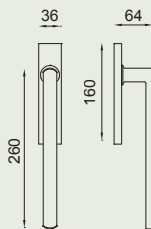

LC60



LC26 - singolo

LC28 - set

**short**







Linee morbide dall'appeal immediato. Una maniglia dal design compatto ed equilibrato, molto apprezzata per la sua versatilità di applicazione in termini di stile e finiture.

*The immediate appeal of soft lines. A compact and balanced design defines this handle, very appreciated thanks to its versatility, both style and finishes.*

# short

**design:**  
**Karim Rashid**

made in italy



**SH40**  
OC

256-

**dnd**22-23

Ottone stampato a caldo  
Hot stamped brass



**AB**  
Bronzato  
Antique bronze



**OC**  
Power cromo lucido  
Power polished chrome

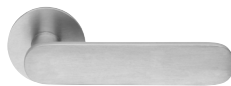

**PCS**  
Power cromo satinato  
Power satin chrome



**ONO**  
Nero  
Black



**PGS | forte®**  
Grafite satinato  
Satin graphite



**PVD-SG | forte®**  
Oro antico satinato  
Antique satin gold



**PVD-SCB | forte®**  
Rame satinato  
Satin copper

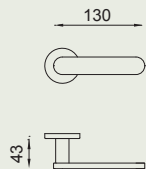

- VIS** SH12
- FINE** SH40
- U** SH80



- VIS** SH22V
- U** SH22U

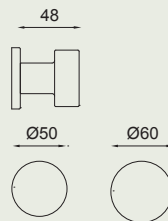

- VIS** RO43 - 50 mm
- RO39 - 60 mm

**esa due**





L'accostamento  
di due diversi  
materiali in un gioco  
di sintesi formale e  
compositiva.

*The combination of  
two different materials  
in a game of formal  
and compositional  
synthesis.*

**esa due**

**design: Dnd  
technical division**

made in italy

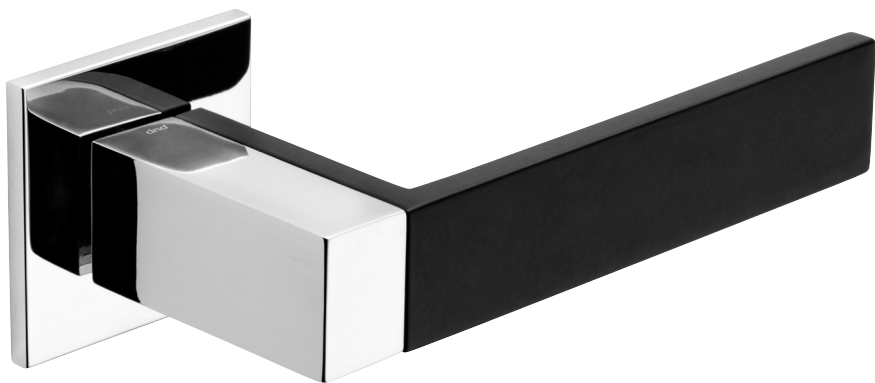

**EU41  
ONE**

260-

**dnd**22-23

Alluminio e zama  
*Aluminium and zamak*



**CCS**

Cromo - Power cromo satinato  
*Chrome - Power satin chrome*

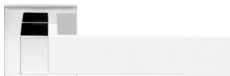

**CBI**

Cromo - bianco  
*Chrome - white*



**CNE**

Cromo - nero  
*Chrome - Black*

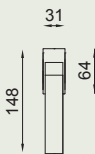
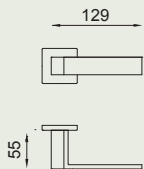

**VIS** EU14

**VIS** EU25V

**FINE** EU41

 EU25TS

**esa**

**design:**  
**Mauro Ronchi**

made in italy



**ES14**  
SBI

262-

**dnd**22-23



Alluminio e zama  
*Aluminium and zamak*



**CCS**  
 Cromo - Power cromo satinato  
*Chrome - Power satin chrome*



**CBI**  
 Cromo - bianco  
*Chrome - white*



**CNE**  
 Cromo - nero  
*Chrome - Black*



**SBI new**  
 Cromo satinato - bianco  
*Satin chrome - white*



**SNE new**  
 Cromo satinato - nero  
*Satin chrome - black*



**ZNE new**  
 Nero  
*Black*

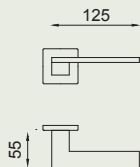

**VIS** ES14

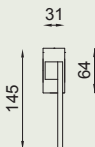

**VIS** ES25V

 ES25TS

# holly

**design: Dnd**  
**technical division**

made in italy



**HO14**  
ZOS

264-

**dnd**22-23

Zama  
Zamak



**ZCS**  
Cromo satinato  
*Satin chrome*



**ZNE**  
Nero  
*Black*



**ZBN**  
Bianco  
*White*

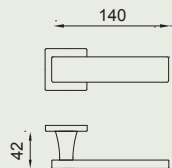

**VIS** HO14



**VIS** HO25V

 HO25TS

# minima

design: Dnd  
technical division

made in italy



**MN12**  
ZONE

266-

**dnd**22-23

Zama  
Zamak



**ZCCS**

Cromo lucido + cromo satinato  
*Polished chrome + satin chrome*



**ZCBI**

Cromo lucido + bianco  
*Polished chrome + white*



**ZCNE**

Cromo lucido + nero  
*Polished chrome + black*

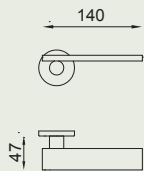

**VIS** MN12



**VIS** MN22V

**LOCK** MN22TS

# chop

**design:**  
**Didier Schweizer**

made in italy



**GP12**  
ZNE

268-

**dnd**22-23

Zama  
Zamak



**ZOS**  
Ottonato satinato  
*Satin brass color*



**ZGH**  
Bronzo satinato opaco  
*Matt satin bronze*



**ZC**  
Cromo lucido  
*Polished chrome*



**ZCS**  
Cromo satinato  
*Satin chrome*



**ZNE**  
Nero  
*Black*



**ZAN**  
Antracite  
*Anthracite*

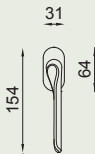
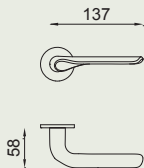

**VIS** CP12

**U** CP80

**VIS** CP22V

**U** CP22TS

**U** CP22U

# fold

design:  
**Mario Padiglione**

made in italy

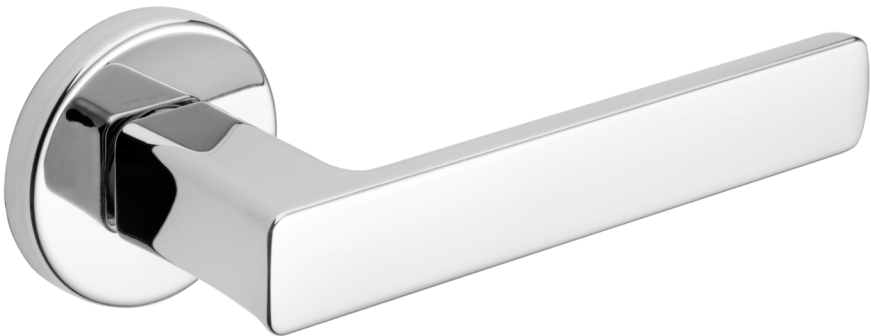

**FO12**  
ZC

270-

**dnd**22-23



Zama  
Zamak



**ZC**  
Cromo lucido  
*Polished chrome*



**ZCS**  
Cromo satinato  
*Satin chrome*



**ZNE**  
Nero  
*Black*



**ZAN**  
Antracite  
*Anthracite*

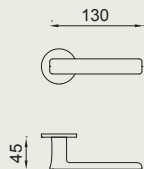

**VIS** FO12

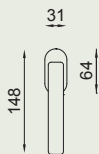

**VIS** FO22V

 FO22TS

# fold 02

design:  
**Mario Padiglione**

made in italy

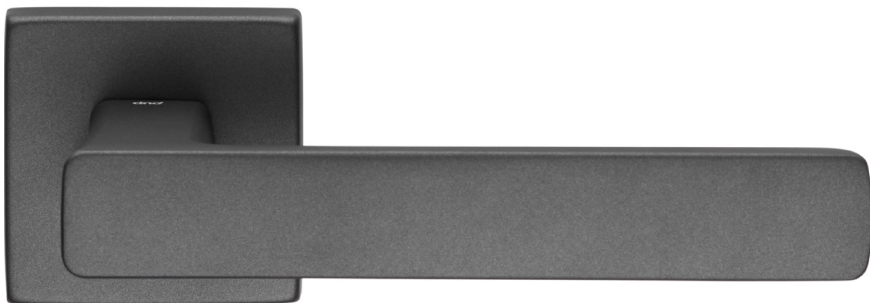

**FO14**  
ZAN

272-

**dnd**22-23

Zama  
Zamak



**ZC**  
Cromo lucido  
*Polished chrome*



**ZCS**  
Cromo satinato  
*Satin chrome*



**ZNE**  
Nero  
*Black*



**ZAN**  
Antracite  
*Anthracite*

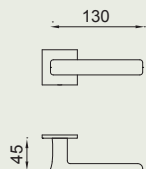

**VIS** FO14

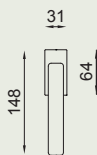

**VIS** FO25V

 FO25TS

# joy

**design:**  
**Nicola Novelletto**

made in italy



**JO12**  
ZNE

274-

**dnd**22-23

Zama  
Zamak



**ZC**  
Cromo lucido  
*Polished chrome*



**ZCS**  
Cromo satinato  
*Satin chrome*



**ZNS**  
Nickel satinato  
*Satin nickel*



**ZNE**  
Nero  
*Black*



**ZAN**  
Antracite  
*Anthracite*

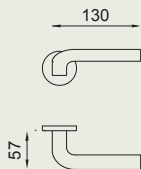

**VIS** JO12



**VIS** JO22V

 JO22TS

# joy 02

design:  
**Nicola Novelletto**

made in italy



**JO14**  
ZOS

276-

**dnd**22-23

Zama  
Zamak



**ZC**  
Cromo lucido  
*Polished chrome*



**ZCS**  
Cromo satinato  
*Satin chrome*



**ZNS**  
Nickel satinato  
*Satin nickel*



**ZNE**  
Nero  
*Black*



**ZAN**  
Antracite  
*Anthracite*

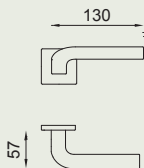

**VIS** JO14



**VIS** JO25V



JO25TS

# sochic

**design: Dnd  
technical division**

made in italy



**SC14**  
ZNE

278-

**dnd**22-23



Zama  
Zamak



**ZC**  
Cromo lucido  
*Polished chrome*



**ZOR**  
Placcato oro 24 k  
*Gold plated 24 k*



**ZNE**  
Nero  
*Black*



**sochic 02 - ZC**  
Cromo lucido  
*Polished chrome*



**sochic 02 - ZOR**  
Placcato oro 24 k  
*Gold plated 24 k*



**sochic 02 - ZNE**  
Nero  
*Black*

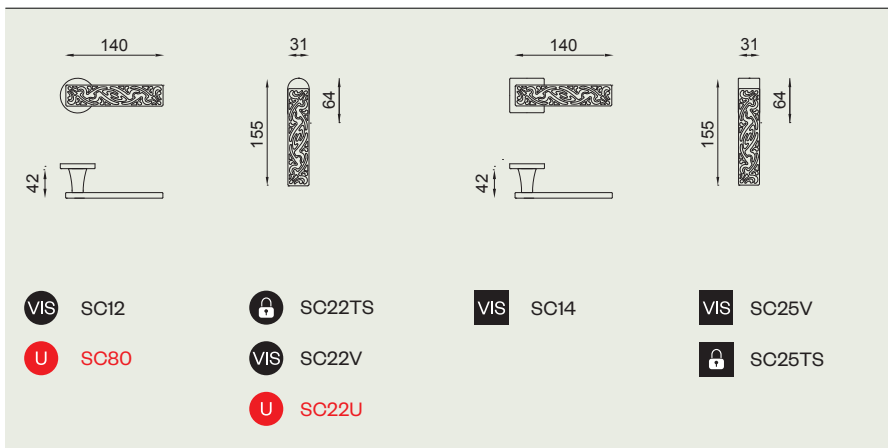

# sochic L

design: Dnd  
technical division

made in italy



**SL12**  
NLS

280-

**dnd**22-23

Zama  
Zamak



**NLS**

Nero + inserto  
larice sabbia  
*Black + sand*  
*Larchwood insert*



**NPB**

Nero + inserto  
palissandro bianco  
*Black + white*  
*Rosewood insert*



**sochic L 02 - SPL**

Cromo satinato  
+ inserto palissandro scuro  
*Satin chrome*  
*+ dark Rosewood insert*



**sochic L 02 - SRT**

Cromo satinato  
+ inserto rovere tanché  
*Satin chrome*  
*+ tanché Oakwood insert*

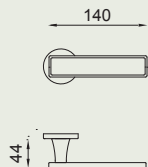

**VIS** SL12

**FINE** SL40

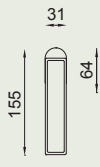

**VIS** SL22V

**LOCK** SL22TS

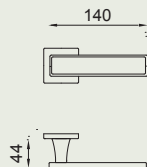

**VIS** SL14

**FINE** SL41

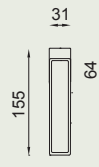

**VIS** SL25V

**LOCK** SL25TS

# art

design:  
**Mauro Ronchi**

made in italy



**AR40**  
OC

282-

**dnd**22-23

Ottone stampato a caldo  
Hot stamped brass



**OGH**  
Bronzo satinato opaco  
Matt satin bronze



**OC**  
Power cromo lucido  
Power polished chrome



**PCS**  
Power cromo satinato  
Power satin chrome



**ONS**  
Nickel satinato  
Satin nickel



**PVD | forte®**  
Ottone lucido  
Polished brass

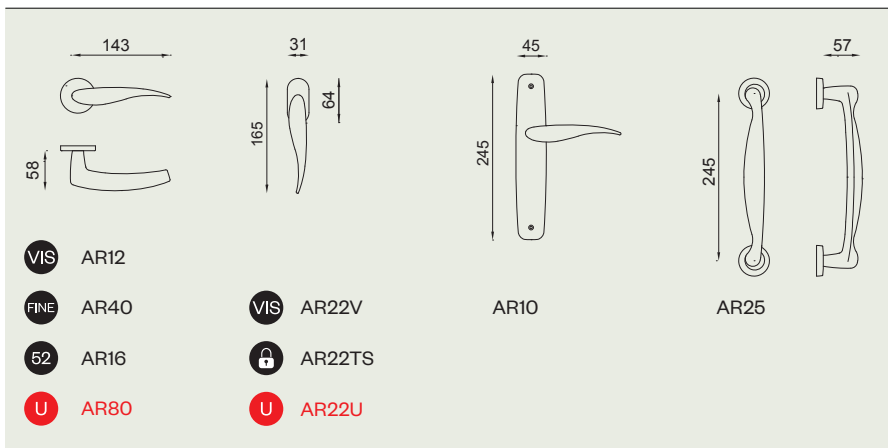

# linear

design:  
**Mauro Ronchi**

made in italy



**LI40**  
PVD-SG | forte®

284-

**dnd**22-23

Ottone stampato a caldo  
Hot stamped brass



**OGH**  
Bronzo satinato opaco  
Matt satin bronze



**OC**  
Power cromo lucido  
Power polished chrome



**PCS**  
Power cromo satinato  
Power satin chrome



**PVD-BG | forte®**  
Oro antico lucido  
Antique bright gold



**PVD-SG | forte®**  
Oro antico satinato  
Antique satin gold

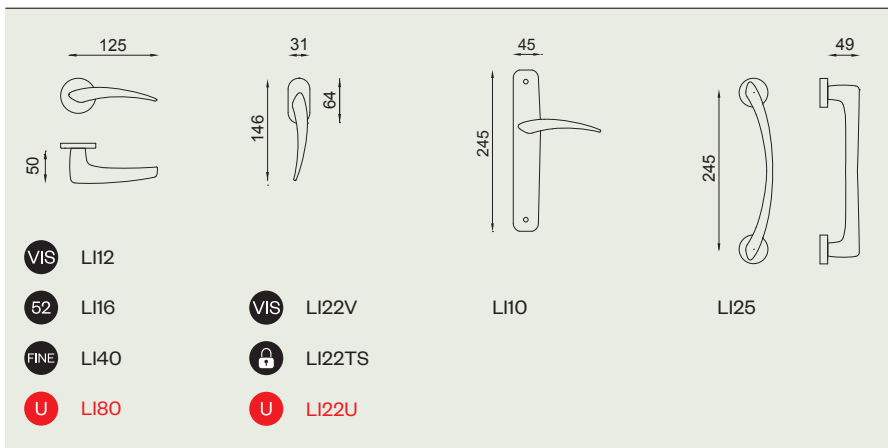

# dolce

design:  
**Mauro Ronchi**

made in italy



**DO40**  
OGH

286-

**dnd**22-23



Ottone stampato a caldo  
*Hot stamped brass*



**OGH**  
Bronzo satinato opaco  
*Matt satin bronze*



**OC**  
Power cromo lucido  
*Power polished chrome*



**PCS**  
Power cromo satinato  
*Power satin chrome*



**ONS**  
Nickel satinato  
*Satin nickel*

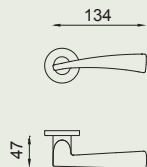

- DO12
- DO40
- DO16

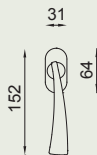

- DO22V
- DO22TS

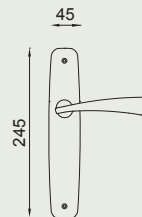

DO10

# blip

design:  
**Karim Rashid**

made in italy



**BL16**  
OC

288-

**dnd**22-23

Ottone  
Solid brass



**OC**  
Power cromo lucido  
*Power polished chrome*



**PCS**  
Power cromo satinato  
*Power satin chrome*



**ONO**  
Nero  
*Black*

145



64



**VIS** BL12

**52** BL16

# twist

design:  
**Karim Rashid**

made in italy



**TW14**  
OC

290-

**dnd**22-23

Ottone stampato a caldo  
Hot stamped brass



**OC**  
Power cromo lucido  
*Power polished chrome*



**PCS**  
Power cromo satinato  
*Power satin chrome*



**ONS**  
Nickel satinato  
*Satin nickel*



**twist 02 - OC**  
Power cromo lucido  
*Power polished chrome*



**twist 02 - PCS**  
Power cromo satinato  
*Power satin chrome*



**twist 02 - ONS**  
Nickel satinato  
*Satin nickel*

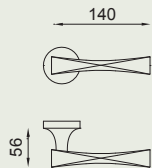

**VIS** TW12

**R** TW14

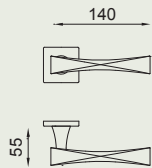

**VIS** TW13

**52** TW18

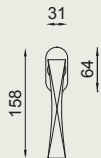

**VIS** TW22V

**🔒** TW22TS

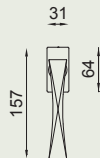

**VIS** TW25V

**🔒** TW25TS

# sike

design:  
**Karim Rashid**

made in italy



**SK14**  
OC

292-

**dnd**22-23

Ottone stampato a caldo  
Hot stamped brass



**OGK**  
Bronzo satinato opaco  
Matt satin bronze



**OC**  
Power cromo lucido  
Power polished chrome



**PCS**  
Power cromo satinato  
Power satin chrome



**sike 02 - OGK**  
Bronzo satinato opaco  
Matt satin bronze



**sike 02 - OC**  
Power cromo lucido  
Power polished chrome



**sike 02 - PCS**  
Power cromo satinato  
Power satin chrome



Good Design Awards  
2006

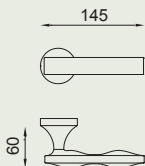

**VIS** SK12

**R** SK14

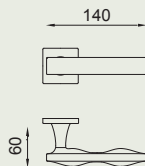

**VIS** SK13

**52** SK18

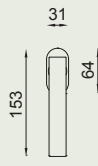

**VIS** SK22V

**LOCK** SK22TS

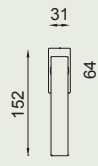

**R** SK25

**LOCK** SK25TS

# project

**design: Dnd**  
**technical division**

made in italy

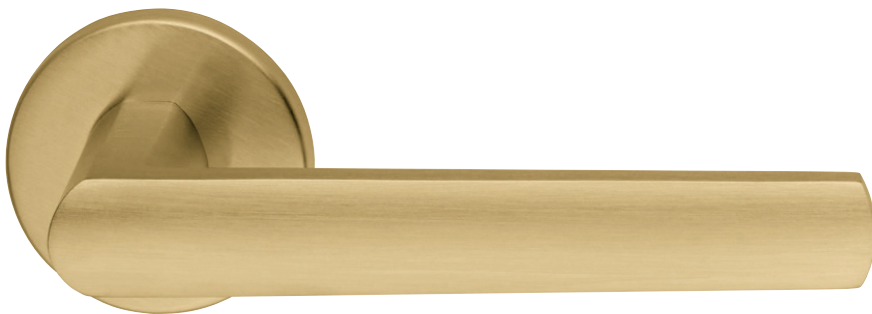

**PR12**  
OS

294-

**dnd**22-23



Ottone stampato a caldo  
Hot stamped brass



**OLV**  
Lucido  
Polished



**OS**  
Satinato  
Satin



**AB**  
Bronzato  
Antique bronze



**OC**  
Power cromo lucido  
Power polished chrome



**PCS**  
Power cromo satinato  
Power satin chrome



**ONS**  
Nickel satinato  
Satin nickel



**ONO**  
Nero  
Black



**V702**  
Marrone scuro  
Dark brown

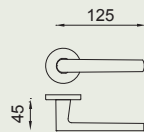

**VIS** PR12

**52** PR16

**FINE** PR40

**S** PR62

**U** PR80



**VIS** PR22V

**S** PR22TS

**U** PR22U



PR35

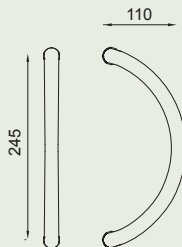

PR27 - singolo

PR29 - singolo

PR26 - set

PR28 - set

# project 02

design: Dnd  
technical division

made in italy

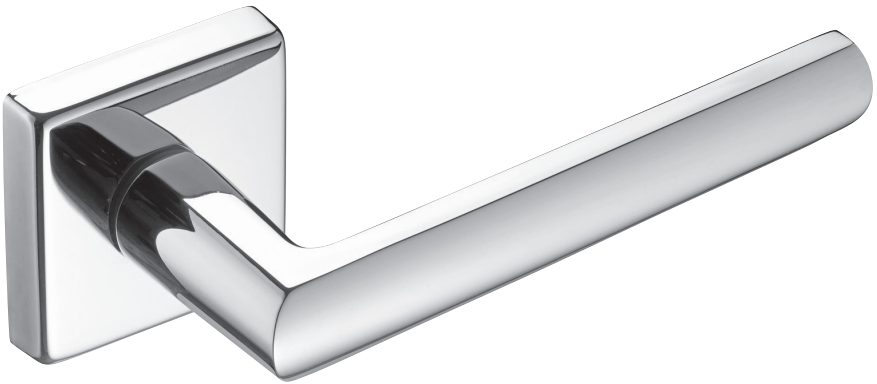

PR14  
OC

296-

dnd/22-23

Ottone stampato a caldo  
Hot stamped brass



**AB**  
Bronzato  
Antique bronze



**OC**  
Power cromo lucido  
Power polished chrome



**PCS**  
Power cromo satinato  
Power satin chrome



**ONS**  
Nickel satinato  
Satin nickel



**ONO**  
Nero  
Black



**V702**  
Marrone scuro  
Dark brown

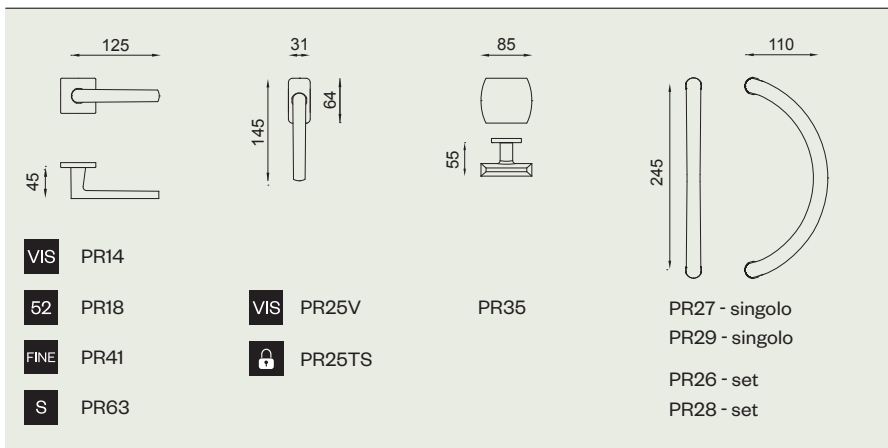

# project zancata

design: Dnd  
technical division

made in italy



PO12  
OC

298-

dnd/22-23

Ottone  
Solid brass



**OC**  
Power cromato lucido  
*Power polished chrome*



**PCS**  
Power cromato satinato  
*Power satin chrome*



**ONS**  
Nickel satinato  
*Satin nickel*



**PVD | forte®**  
Ottone lucido  
*Polished brass*



**project z. 02 - OC**  
Power cromato lucido  
*Power polished chrome*

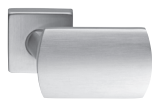

**project z. 02 - PCS**  
Power cromato satinato  
*Power satin chrome*

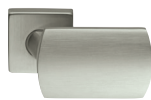

**project z. 02 - ONS**  
Nickel satinato  
*Satin nickel*

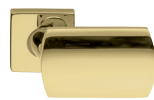

**project z. 02  
PVD | forte®**  
Ottone lucido  
*Polished brass*

94



94



55



55



**VIS** PO12

**VIS** PO14

**52** PO16

**52** PO18

# havana

design:  
**Studio Hot Lab**

made in italy



**HV12**  
PVD-BG | forte®+VE

300-

**dnd**22-23

Ottone stampato a caldo e pelle di prima qualità "pieno fiore"  
*Hot stamped brass and high quality leather*



**OLV + PA**  
 Ottone lucido + Papaya  
*Polished brass + Papaya*



**OC + NA**  
 Power cromo lucido + Navy  
*Power polished chrome + Navy*



**PCS + PA**  
 Power cromo satinato + Papaya  
*Power satin chrome + Papaya*



**PCS + NA**  
 Power cromo satinato + Navy  
*Power satin chrome + Navy*



**PVD-BG | forte® + VE new**  
 Oro antico lucido + Verde  
*Antique bright gold + Green*



**PVD-SG | forte® + VE new**  
 Oro antico satinato + Verde  
*Antique satin gold + Green*

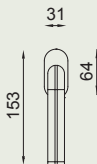
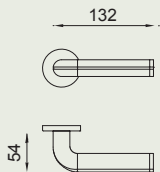

**VIS** HV12

**FINE** HV40

**VIS** HV22V

**🔒** HV22TS

# vita

design:  
**Mauro Ronchi**

made in italy

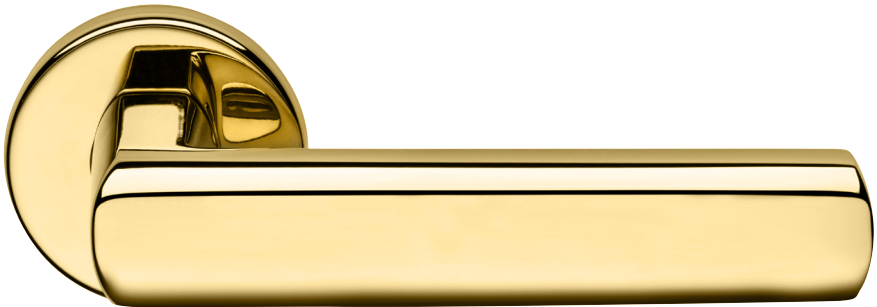

**VI12**  
PVD | forte®

302-

**dnd**22-23



Ottone stampato a caldo  
*Hot stamped brass*



**OC**  
Power cromo lucido  
*Power polished chrome*



**PCS**  
Power cromo satinato  
*Power satin chrome*



**ONS**  
Nickel satinato  
*Satin nickel*



**PGS | forte®**  
Grafite satinato  
*Satin graphite*



**PVD | forte®**  
Ottone lucido  
*Polished brass*



**PVX | forte®**  
Inox satinato  
*Satin steel*

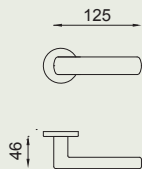

**VIS** VI12

**62** VI16



**VIS** VI22V

**🔒** VI22TS

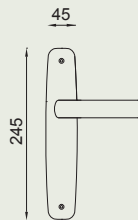

VI10

# vita 02

design:  
**Mauro Ronchi**

made in italy



**V18**  
OC

304-

**dnd**22-23

Ottone stampato a caldo  
*Hot stamped brass*



**OC**  
Power cromo lucido  
*Power polished chrome*



**PCS**  
Power cromo satinato  
*Power satin chrome*



**ONS**  
Nickel satinato  
*Satin nickel*



**PGS | forte®**  
Grafite satinato  
*Satin graphite*



**PVX | forte®**  
Inox satinato  
*Satin steel*

**Fino esaurimento scorte (rosetta 52)**

*While still in stock (52 rose)*

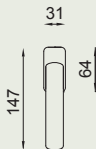
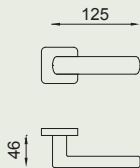

**VIS** VI14

**VIS** VI25V

**52** VI18

**🔒** VI25TS

# fluò

design:  
**Mauro Ronchi**

made in italy



**FL16**  
OLV

306-

**dnd**22-23

Ottone stampato a caldo  
*Hot stamped brass*



**OLV**  
Lucido  
*Polished*



**OC**  
Power cromo lucido  
*Power polished chrome*



**PCS**  
Power cromo satinato  
*Power satin chrome*

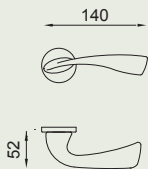

**VIS** FL12

**52** FL16

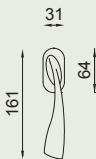

**VIS** FL22V

**🔒** FL22TS

**go**

**design:**  
**Mauro Ronchi**

made in italy



**GO16**  
OC

308-

**dnd**22-23

Ottone stampato a caldo  
*Hot stamped brass*



**OC**  
Power cromo lucido  
*Power polished chrome*



**PCS**  
Power cromo satinato  
*Power satin chrome*

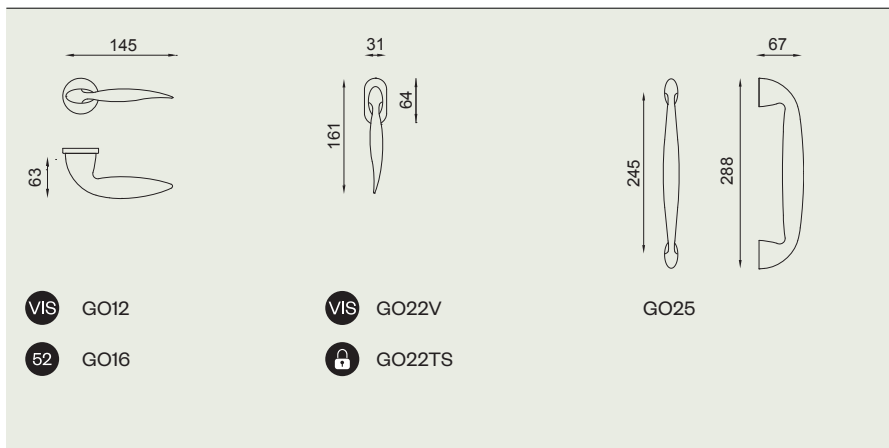

# mix

**design: Dnd**  
**technical division**

made in italy



**M112**  
OC+R

310-

**dnd**22-23



Ottone, zama e acciaio  
*Brass, zamak and stainless steel*



**OC + R**  
Cromo lucido + rete  
*Polished chrome + screen*



**OCS + R**  
Cromo satinato + rete  
*Satin chrome + screen*



**CNE**  
Cromo lucido - nero  
*Polished chrome - black*



**CSNE**  
Cromo satinato - nero  
*Satin chrome - black*

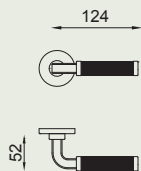

**VIS** MI12

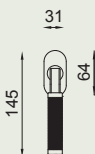

**VIS** MI22V

 MI22TS

# stick 02

design:  
Novelletto - Greco

made in italy

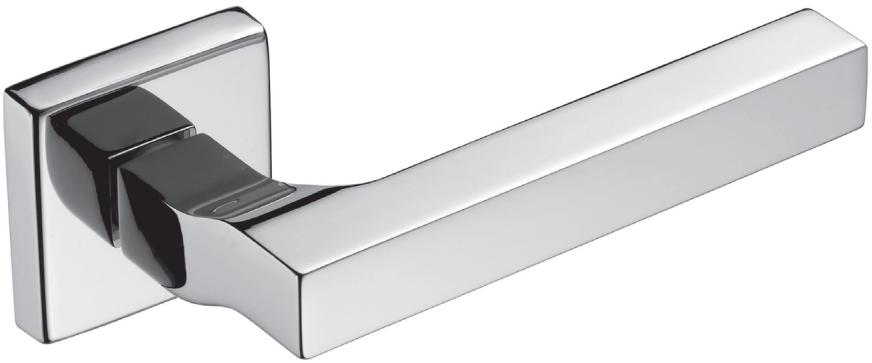

861/14  
ZC

312-

dnd/22-23

Zama  
Zamak



**ZC**  
Cromo lucido  
*Polished chrome*



**ZCS**  
Cromo satinato  
*Satin chrome*

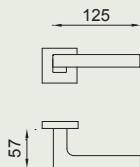

**VIS** 861/14

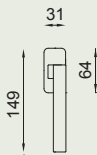

**VIS** 866V

 866TS

# quattro 02 Z

Zama / Zamak

design: Dnd  
technical division

made in italy



VIS 264/14-Z  
ZC



# link

Ottone stampato a caldo / Hot stamped brass

design:  
Mauro Ronchi

made in italy



VIS 653/12  
OC



# nova

Ottone stampato a caldo / Hot stamped brass

design:  
Mauro Ronchi

made in italy



VIS 663/12  
OCS



# tipo

Zama / Zamak

design:  
Pietro Silva

made in italy



VIS 172/12-Z  
ZC



314-

dnd 22-23

# S40

Acciaio inox AISI 316 / *Stainless steel AISI 316*

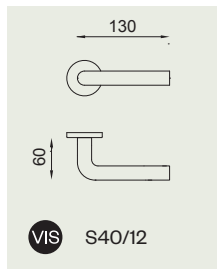

# S50

Acciaio inox AISI 316 / *Stainless steel AISI 316*

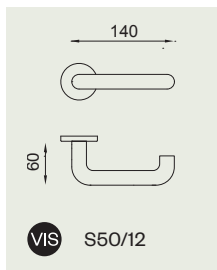

# S60

Acciaio inox AISI 316 / *Stainless steel AISI 316*

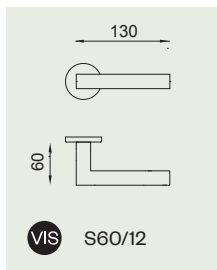

maniglie

– classic  
handles

classic

# fiorenza

design: Dnd  
technical division

made in italy



519  
ORO

318-

dnd/22-23



Ottone stampato a caldo  
*Hot stamped brass*



**OGH**  
Bronzo satinato opaco  
*Matt satin bronze*



**ONV**  
Nickel lucido  
*Polished nickel*



**OROF**  
Oro francese antico  
*French antique gold*



**ORO**  
Placcato oro 24k  
*Gold plated 24k*



**VIS** 523/12

**R** 523



**VIS** 521V

**🔒** 521TS

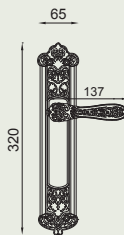

519

# fiore

**design: Dnd  
technical division**

made in italy



**525**  
OGH

320-

**dnd**22-23

Ottone stampato a caldo  
*Hot stamped brass*



**OGH**  
Bronzo satinato opaco  
*Matt satin bronze*



**ONV**  
Nickel lucido  
*Polished nickel*



**OROF**  
Oro francese antico  
*French antique gold*



**ORO**  
Placcato oro 24k  
*Gold plated 24k*

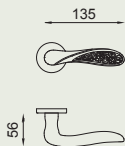

**VIS** 522/12

**R** 522



**VIS** 526V

**🔒** 526TS

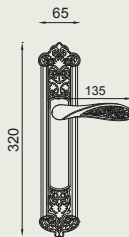

525

# fedora

**design: Dnd  
technical division**

made in italy



**530/12**  
AB

322-

**dnd**22-23

Ottone stampato a caldo  
*Hot stamped brass*



**AB**  
Bronzato  
*Antique bronze*



**OGH**  
Bronzo satinato opaco  
*Matt satin bronze*



**PCS**  
Power cromo satinato  
*Power satin chrome*



**PVD-BG | forte®**  
Oro antico lucido  
*Antique bright gold*



**PVD-SG | forte®**  
Oro antico satinato  
*Antique satin gold*

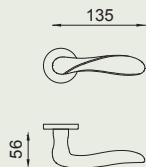

**VIS** 530/12

**R** 528

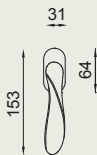

**VIS** 529V

**🔒** 529/TS

# **lirica**

**design: Dnd  
technical division**

made in italy



**806/12**  
ONV

324-

**dnd**22-23

Ottone  
Solid brass



**OLV**  
Lucido  
*Polished*



**AF**  
Anticato  
*Antique finish*



**BSS**  
Bronzo scuro sfumato  
*Shaded dark bronze*



**OCS**  
Cromo satinato  
*Satin chrome*



**ONV**  
Nickel lucido  
*Polished nickel*



**FAN**  
Ferro anticato  
*Antique iron*

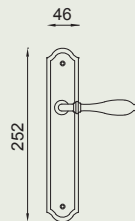
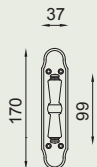
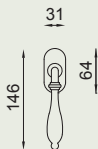
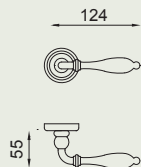

**VIS** 806/12

**B** 801/B

**V** 803

**VIS** 805V

**🔒** 805TS

394

395

800

# classic

**design: Dnd  
technical division**

made in italy



**571/12**  
OLV

326-

**dnd**22-23



Ottone  
Solid brass



**OLV**  
Lucido  
Polished



**OS**  
Satinato  
Satin



**AB**  
Bronzato  
Antique bronze



**OGH**  
Bronzo satinato opaco  
Matt satin bronze

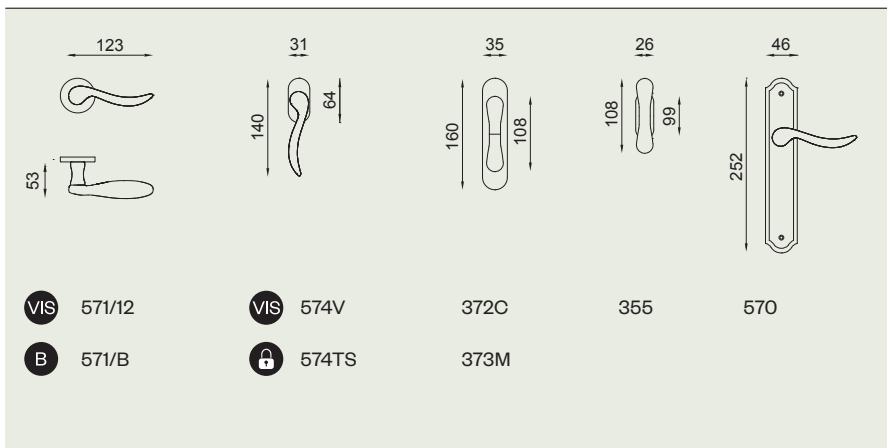

# ardea

design:  
**Mauro Ronchi**

made in italy

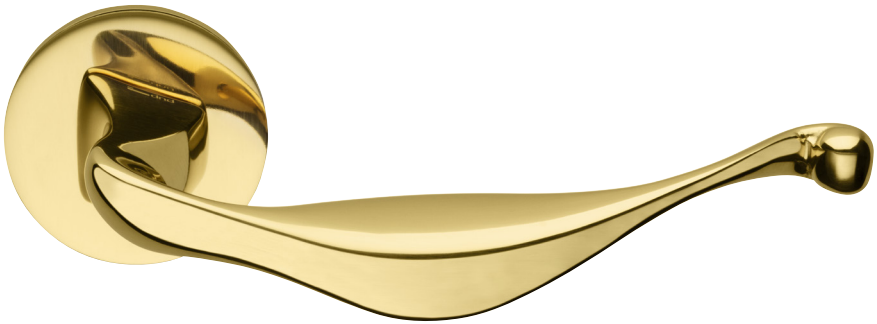

**AD12**  
OLV

328-

**dnd**22-23

Ottone stampato a caldo  
*Hot stamped brass*



**OLV**  
Lucido  
*Polished*



**OGH**  
Bronzo satinato opaco  
*Matt satin bronze*



**ONV**  
Nickel lucido  
*Polished nickel*



**OLV**  
Lucido  
*Polished*



**ONV**  
Nickel lucido  
*Polished nickel*



**VIS** AD12

**R** AD13

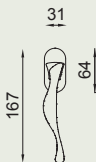

**VIS** AD22V

**🔒** AD22TS

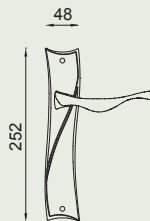

AD10

# cassia

design:  
**Mauro Ronchi**

made in italy



**CA13**  
OLV

330-

**dnd**22-23

Ottone stampato a caldo  
*Hot stamped brass*



**OLV**  
Lucido  
*Polished*



**OGH**  
Bronzo satinato opaco  
*Matt satin bronze*

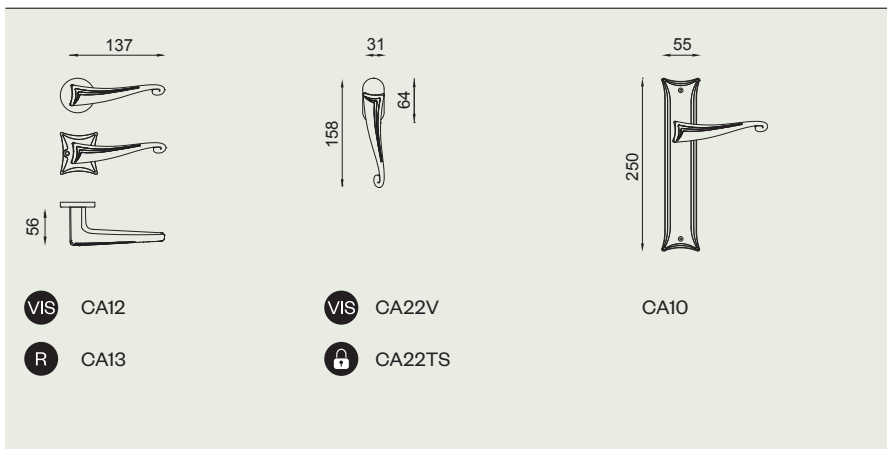

# beverly

design:  
**Mauro Ronchi**

made in italy



141/12  
OLV

332-

dnd/22-23

Ottone stampato a caldo  
*Hot stamped brass*



**OLV**  
Lucido  
*Polished*

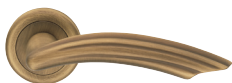

**OGH**  
Bronzo satinato opaco  
*Matt satin bronze*

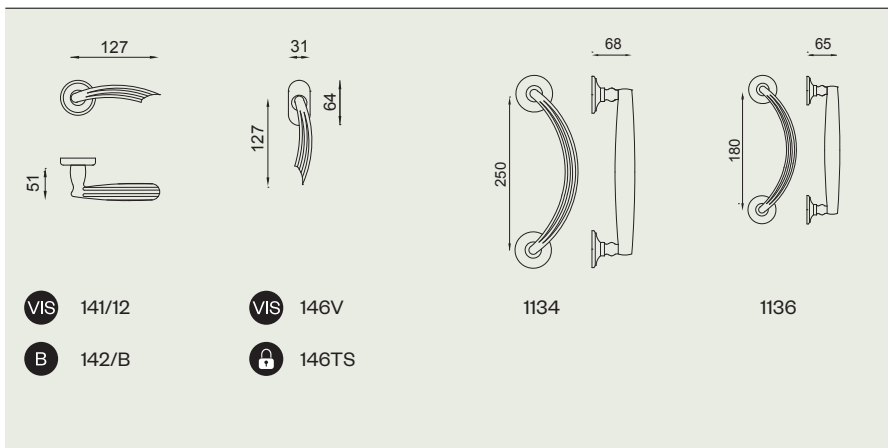

# latina

design:  
**Mauro Ronchi**

made in italy



**823/12**  
OLV

334-

**dnd**22-23



Ottone stampato a caldo  
*Hot stamped brass*



**OLV**  
Lucido  
*Polished*



**OGH**  
Bronzo satinato opaco  
*Matt satin bronze*



**BSS**  
Bronzo scuro sfumato  
*Shaded dark bronze*



**VIS** 823/12

**R** 824



**VIS** 829V

**🔒** 829TS



820



1110

# lady

**design: Dnd  
technical division**

made in italy



**568/B**  
OLV

336-

**dnd**22-23

Ottone stampato a caldo  
*Hot stamped brass*



**OLV**  
Lucido  
*Polished*



**OGH**  
Bronzo satinato opaco  
*Matt satin bronze*



**BSS**  
Bronzo scuro sfumato  
*Shaded dark bronze*



**OC**  
Cromo lucido  
*Polished chrome*



**OCS**  
Cromo satinato  
*Satin chrome*



**VIS** 568/12

**B** 568/B



**VIS** 565V

**🔒** 565TS

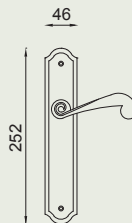

567

# appia

design:  
**Mauro Ronchi**

made in italy



**833/12**  
BSS

338-

**dnd**22-23

Ottone stampato a caldo  
*Hot stamped brass*



**OLV**  
Lucido  
*Polished*



**OGH**  
Bronzo satinato opaco  
*Matt satin bronze*



**BSS**  
Bronzo scuro sfumato  
*Shaded dark bronze*



**VIS** 833/12

**R** 834



**VIS** 839V

**🔒** 839TS

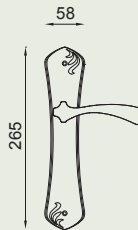

830

# airone

Ottone / Solid brass

design:  
**Mauro Ronchi**

made in italy



**VIS** 603/12  
OLV

- OLV
- OGC
- OS
- OC
- OCS

# beauty

Ottone / Solid brass

design: **Dnd**  
**technical division**

made in italy



**VIS** 775/B  
OLV

- OLV
- OGH
- AF
- OCS
- FAN

# bruxelles

Ottone / Solid brass

design: **Dnd**  
**technical division**

made in italy



**VIS** 362/12  
FAN

- OLV
- OGH
- AF
- OCS
- FAN

# daniela

Ottone / Solid brass



VIS 391/12  
OLV

design: Dnd  
technical division

made in italy



# daniela porcellana

Ottone / Solid brass



VIS 391/12  
ONV + P1

design: Dnd  
technical division

made in italy



P1= porcellana bianca /  
white porcelain  
P6= porcellana avorio /  
ivory porcelain

# lorena

Ottone / Solid brass



VIS 251/12  
OLV

design: Dnd  
technical division

made in italy



# combinazioni particolari

—



combinations

# Kit hotel maniglia-pomolo / *Knob-handle hotel kit*



**Principali soluzioni /  
Main solutions**

Maniglia / handle  
Pomolo / knob

**ARETÈ L 02  
RING**

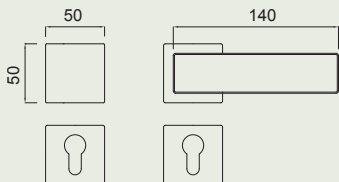

Maniglia / handle  
Pomolo / knob

**CHANGE B 02  
RING**

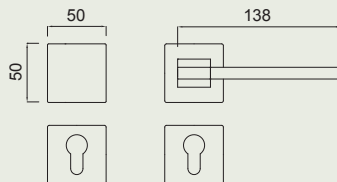

Maniglia / handle  
Pomolo / knob

**EDRA 02  
RING**

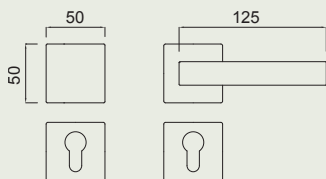

Maniglia / handle  
Pomolo / knob

**LUXURY 02  
RING**

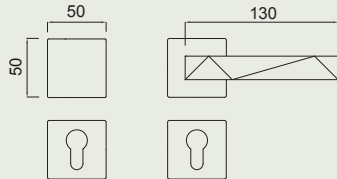

Maniglia / handle  
Pomolo / knob

**QUATTRO 02  
QUADRO**

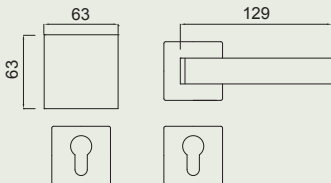

# Kit hotel maniglia-pomolo / *Knob-handle hotel kit*

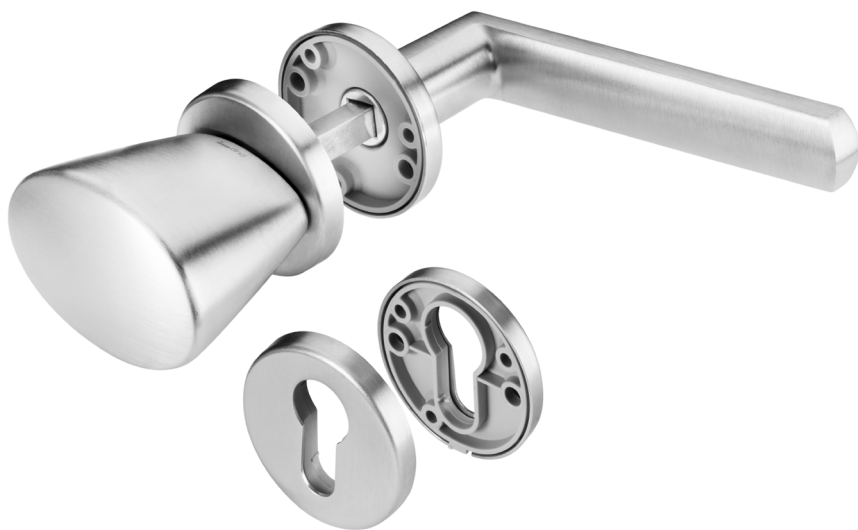

**Principali soluzioni /  
Main solutions**

Maniglia / handle  
Pomolo / knob

**TIMELESS**  
**TIMELESS**

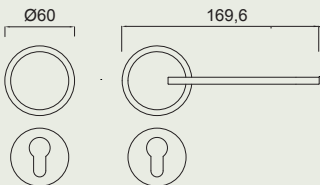

Maniglia / handle  
Pomolo / knob

**LUCE**  
**RONDÒ**

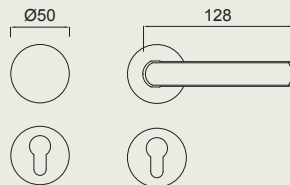

Maniglia / handle  
Pomolo / knob

**CHOP**  
**RONDÒ**

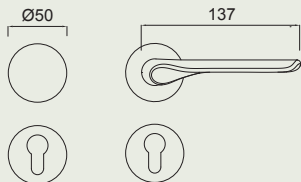

Maniglia / handle  
Pomolo / knob

**SAFETY**  
**RONDÒ**

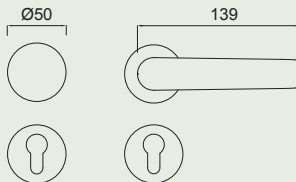

Maniglia / handle  
Pomolo / knob

**SHORT**  
**RONDÒ**

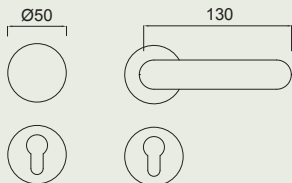

Maniglia / handle  
Pomolo / knob

**ART**  
**RONDÒ**

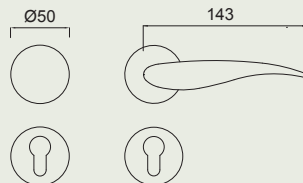

maniglie

– windows

# per finestre

# handles

Per tutti i modelli di maniglie è disponibile il sistema per finestra (dk).  
A seguire alcuni esempi.

*Window handles (dk) are available for all our door handle models.  
In the following pages some examples.*

# aretè

Ottone forgiato  
*Forged brass*



design:  
**Mauro Ronchi**

made in italy

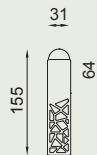

- AB
- OGH
- OC
- PCS
- PGS | forte®
- PVX | forte®
- PVD-SG | forte®

VIS AT22V

AT22TS

# aretè 02

Ottone forgiato  
*Forged brass*



design:  
**Mauro Ronchi**

made in italy

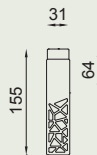

- AB
- OGH
- OC
- PCS
- PGS | forte®
- PVX | forte®
- PVD-SG | forte®

AT25

VIS AT25V

AT25TS



# C-1918

Acciaio inox AISI 316 + rame  
*AISI Stainless steel 316 + copper*



**design:**  
**Achille Castiglioni**  
**Gianfranco Cavaglia**

made in italy

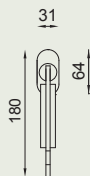

-  S316 + R
-  L316 + R
-  S316 + N
-  L316 + N

CC22

# cloe 02

Ottone stampato a caldo  
*Hot stamped brass*



**design: Dnd**  
**technical division**

made in italy

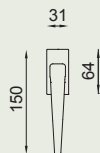

-  OC
-  PCS
-  PGS | forte®
-  PVD-BG | forte®
-  PVD-SG | forte®

 CL25V

 CL25TS

# change B02

Ottone stampato a caldo  
*Hot stamped brass*

design:  
**Sandro Santantonio**

made in italy

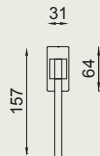

- CCS
- OBN
- ONO
- V702

- R CB25
- VIS CB25V
- CB25TS

# edra 02

Ottone stampato a caldo  
*Hot stamped brass*

design:  
**Mauro Ronchi**

made in italy

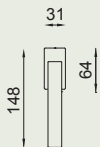

- OGH
- OC
- PCS
- ONO
- ONS
- PGS | forte®
- PVX | forte®
- PVD-SG | forte®
- PVD-SCB | forte®

- R ED25
- VIS ED25V
- ED25TS

# esa due

Alluminio e zama  
*Aluminium and zamak*

**design: Dnd  
technical division**

made in italy

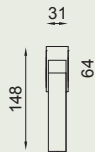

**VIS** EU25V

**LOCK** EU25TS

# fluke

Ottone stampato a caldo  
*Hot stamped brass*

**design:  
Karim Rashid**

made in italy

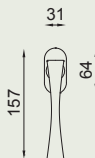

**VIS** FK22V

**LOCK** FK22TS

# luxury 02

Ottone stampato a caldo  
*Hot stamped brass*

design:  
**Mauro Ronchi**

made in italy

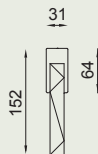

- R** LU25
- VIS** LU25V
- 🔒** LU25TS

- OGH
- OC
- PCS
- ONO
- PGS | forte®
- PVD-BG | forte®
- PVD-SG | forte®
- PVD-SCB | forte®

# ginkgo

Ottone stampato a caldo  
*Hot stamped brass*

design:  
**Giulio Iacchetti**

made in italy



- VIS** GK22V
- 🔒** GK22TS

- OC
- PCS
- ONO
- PGS | forte®
- PVD-BG | forte®
- PVD-SG | forte®

# ginkgo biloba

Ottone stampato a caldo  
*Hot stamped brass*

design:  
**Giulio lacchetti**

made in italy

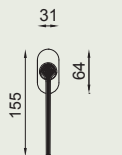

OC

PCS

ONO

PGS | forte®

PVD-BG | forte®

PVD-SG | forte®

VIS GB22V

GB22TS

# isabella

Ottone stampato a caldo  
*Hot stamped brass*

design:  
**Marco Pisati**

made in italy

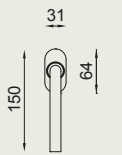

OGH

OC

ONV

PGS | forte®

PVD-BG | forte®

PVD-SG | forte®

VIS IS22V

IS22TS

# lucrezia

Ottone stampato a caldo  
Hot stamped brass

design:  
Marco Pisati

made in italy

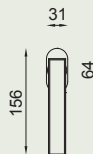

- OGH
- ONV
- PGS | forte®
- PVD-BG | forte®
- PVD-SG | forte®

VIS LT30V

LT30TS

# luce

Zama  
Zamak

design: Dnd  
technical division

made in italy

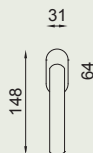

- ZGH
- ZC
- ZCS
- ZNS
- ZNE
- ZAN

VIS LC30V

LC30TS

# luce 02

Zama  
Zamak

design: Dnd  
technical division

made in italy

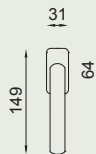

- ZGH
- ZC
- ZCS
- ZNS
- ZNE
- ZAN

VIS LC31V  
LOCK LC31TS

# short

Ottone stampato a caldo  
*Hot stamped brass*

design:  
Karim Rashid

made in italy

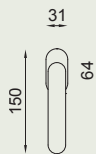

- AB
- OC
- PCS
- ONO
- PGS | forte®
- PVD-SG | forte®
- PVD-SCB | forte®

VIS SH22V  
LOCK SH22TS

# maniglioni

—



pull handles

# pod

NEW

Ottone stampato a caldo  
*Hot stamped brass*

design:  
**Holscher Design**

made in italy

-  **OLV**  
Lucido  
*Polished*
-  **OC**  
Power cromo lucido  
*Power polished chrome*
-  **PCS**  
Power cromo satinato  
*Power satin chrome*
-  **ONO**  
Nero  
*Black*
-  **PVD-BG | forte®**  
Oro antico lucido  
*Antique bright gold*
-  **PVD-SG | forte®**  
Oro antico satinato  
*Antique satin gold*
-  **PGS | forte®**  
Grafite satinato  
*Satin graphite*

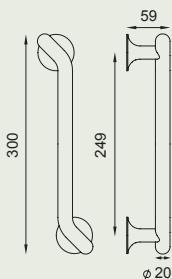
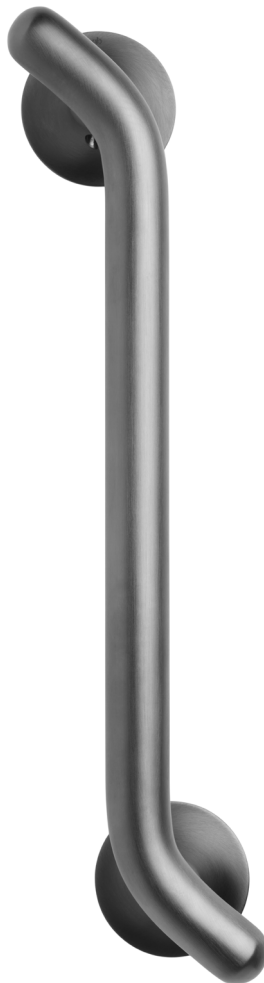

PD27 - singolo  
PD28 - set

360-

dnd22-23

# zeppelin

NEW

design:  
Jaime Hayon

Ottone forgiato  
*Forged brass*

made in italy



**ONV**  
Nickel lucido  
*Polished nickel*



**OVE**  
Verde  
*Green*



**ONO**  
Nero  
*Black*



**PVD-BG | forte®**  
Oro antico lucido  
*Antique bright gold*



**PVD-SG | forte®**  
Oro antico satinato  
*Antique satin gold*



**PVD-SCB | forte®**  
Rame satinato  
*Satin copper*



**PGS | forte®**  
Grafite satinato  
*Satin graphite*

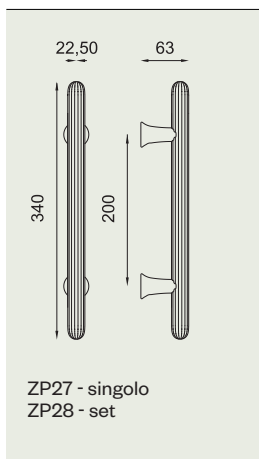

# (IN)finito

NEW

design:  
**Alfonso Femia**

Ottone  
*Solid brass*

made in italy



**OLV**  
Lucido  
*Polished*



**AB**  
Bronzato  
*Antique bronze*



**SO**  
Sabbato opaco  
*Matt sandblasted*



**PCS**  
Power cromo satinato  
*Power satin chrome*



**ONO**  
Nero  
Black

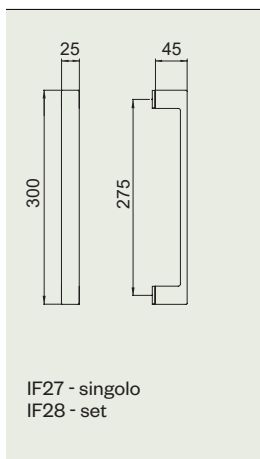

362-

dnd22-23

# (IN)finito NEW

Ottone  
Solid brass

design:  
Alfonso Femia

made in italy



**OLV**  
Lucido  
*Polished*



**AB**  
Bronzato  
*Antique bronze*



**SO**  
Sabbiato opaco  
*Matt sandblasted*



**PCS**  
Power cromo satinato  
*Power satin chrome*



**ONO**  
Nero  
Black

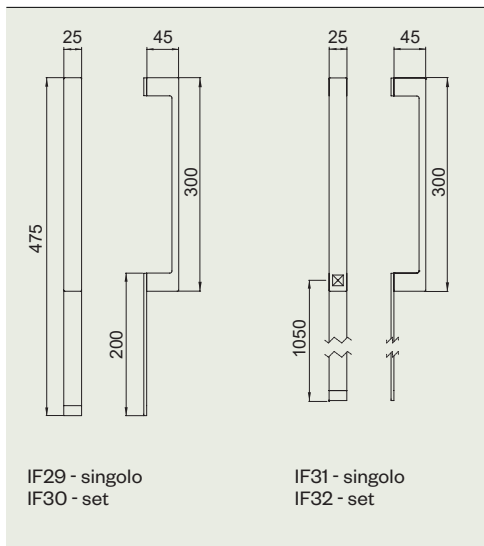

# eleonora

NEW

design:  
Marco Pisati

Ottone forgiato  
*Forged brass*

made in italy



**OGH**  
Bronzo satinato opaco  
*Matt satin bronze*



**ONV**  
Nickel lucido  
*Polished nickel*



**PVD-BG | forte®**  
Oro antico lucido  
*Antique bright gold*



**PVD-SG | forte®**  
Oro antico satinato  
*Antique satin gold*



**PGS | forte®**  
Grafite satinato  
*Satin graphite*

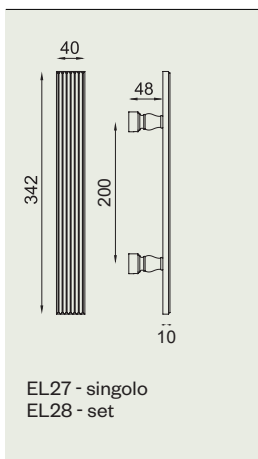

364-

dnd22-23

# eleonora NEW

Ottone forgiato  
*Forged brass*

design:  
**Marco Pisati**

made in italy



**OGH**

Bronzo satinato opaco  
*Matt satin bronze*



**ONV**

Nickel lucido  
*Polished nickel*



**PVD-BG | forte®**

Oro antico lucido  
*Antique bright gold*



**PVD-SG | forte®**

Oro antico satinato  
*Antique satin gold*



**PGS | forte®**

Grafite satinato  
*Satin graphite*

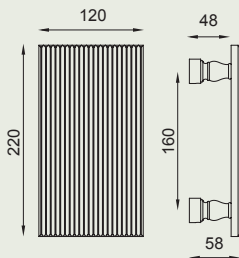
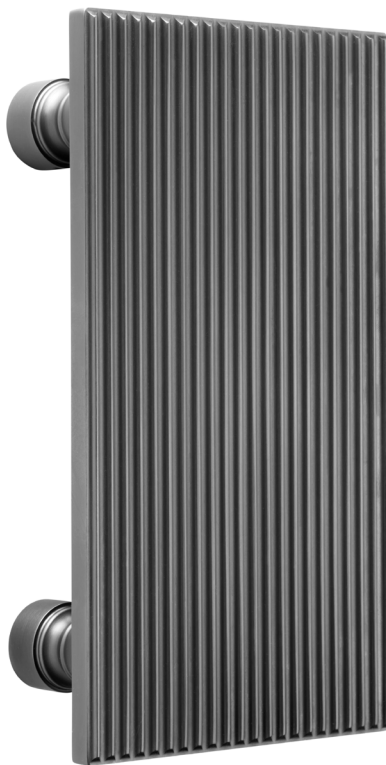

EL29 - singolo  
EL30 - set

# ginkgo

Ottone forgiato  
*Forged brass*

design:  
**Giulio lacchetti**

made in italy

 **PCS**  
Power cromo satinato  
*Power satin chrome*

 **ONV**  
Nickel lucido  
*Polished nickel*

 **ONO**  
Nero  
Black

 **PGS | forte®**  
Grafite satinato  
*Satin graphite*

 **PVD-BG | forte®**  
Oro antico lucido  
*Antique bright gold*

 **PVD-SG | forte®**  
Oro antico satinato  
*Antique satin gold*

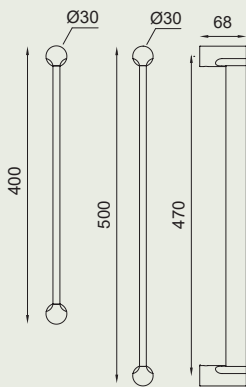
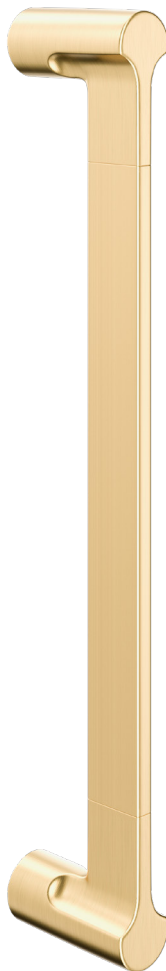

\* GK27 - singolo (400 mm)

\* GK28 - set (400 mm)

\* GK29 - singolo (500 mm)

\* GK30 - set (500 mm)

\* Altre misure disponibili  
su richiesta.  
*Other lengths available  
on request.*



# ginkgo biloba

design:  
Giulio lacchetti

Ottone forgiato  
*Forged brass*

made in italy

 **PCS**  
Power cromo satinato  
*Power satin chrome*

 **ONV**  
Nickel lucido  
*Polished nickel*

 **ONO**  
Nero  
Black

 **PGS | forte®**  
Grafite satinato  
*Satin graphite*

 **PVD-BG | forte®**  
Oro antico lucido  
*Antique bright gold*

 **PVD-SG | forte®**  
Oro antico satinato  
*Antique satin gold*

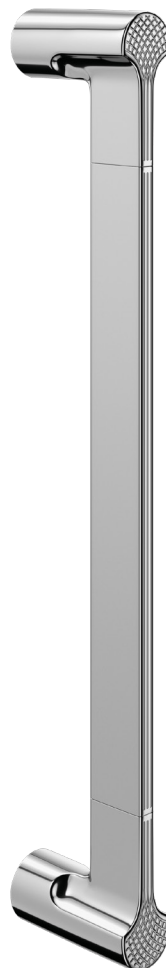
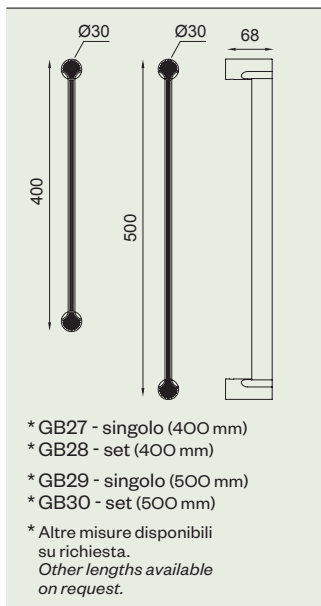

# lucrezia

Ottone forgiato  
*Forged brass*

design:  
**Marco Pisati**

made in italy



**OGH**  
Bronzo satinato opaco  
*Matt satin bronze*



**ONV**  
Nickel lucido  
*Polished nickel*



**PGS | forte®**  
Grafite satinato  
*Satin graphite*



**PVD-BG | forte®**  
Oro antico lucido  
*Antique bright gold*



**PVD-SG | forte®**  
Oro antico satinato  
*Antique satin gold*

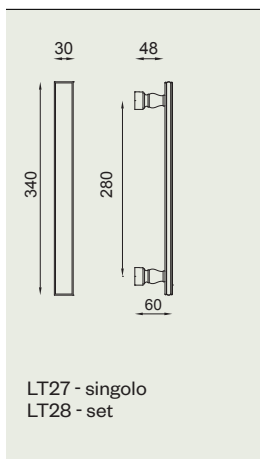

368-

dnd22-23

# luxury

design:  
**Mauro Ronchi**

Ottone stampato a caldo  
*Hot stamped brass*

made in italy



**OGH**

Bronzo satinato opaco  
*Matt satin bronze*



**OC**

Power cromo lucido  
*Power polished chrome*



**PCS**

Power cromo satinato  
*Power satin chrome*



**ONO**

Nero  
Black



**PGS | forte®**

Grafite satinato  
*Satin graphite*



**PVD-BG | forte®**

Oro antico lucido  
*Antique bright gold*



**PVD-SG | forte®**

Oro antico satinato  
*Antique satin gold*



**PVD-SCB | forte®**

Rame satinato  
*Satin copper*

25

40



300



LU27 - singolo  
LU28 - set



# aretè

Ottone forgiato  
*Forged brass*

design:  
**Mauro Ronchi**

made in italy



**AB**  
Bronzato  
*Antique bronze*



**OGH**  
Bronzo satinato opaco  
*Matt satin bronze*



**OC**  
Power cromo lucido  
*Power polished chrome*



**PCS**  
Power cromo satinato  
*Power satin chrome*



**PGS | forte®**  
Grafite satinato  
*Satin graphite*



**PVX | forte®**  
Inox satinato  
*Satin steel*



**PVD-SG | forte®**  
Oro antico satinato  
*Antique satin gold*

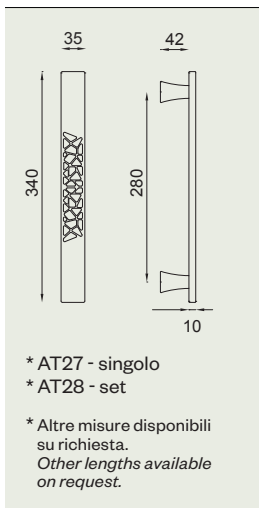

# aretè L

design:  
**Mauro Ronchi**

Ottone forgiato  
*Forged brass*

made in italy



**AB**  
Bronzato  
*Antique bronze*



**OGH**  
Bronzo satinato opaco  
*Matt satin bronze*



**OC**  
Power cromo lucido  
*Power polished chrome*



**PCS**  
Power cromo satinato  
*Power satin chrome*



**PGS | forte®**  
Grafite satinato  
*Satin graphite*



**PVX | forte®**  
Inox satinato  
*Satin steel*



**PVD-SG | forte®**  
Oro antico satinato  
*Antique satin gold*



# C-1918

Acciaio inox AISI 316 + rame  
*AISI Stainless steel 316 + copper*

design:  
**Achille Castiglioni**  
**Gianfranco Cavaglia**

made in italy



## **S316 + R**

AISI 316 satinato  
+ inserto rame PVD  
*AISI 316 satin*  
*+ PVD copper insert*



## **L316 + R**

AISI 316 lucido  
+ inserto rame PVD  
*AISI 316 polished*  
*+ PVD copper insert*



## **S316 + N**

AISI 316 satinato  
+ inserto rame nero  
*AISI 316 satin*  
*+ black copper insert*



## **L316 + N**

AISI 316 lucido  
+ inserto rame nero  
*AISI 316 polished*  
*+ black copper insert*

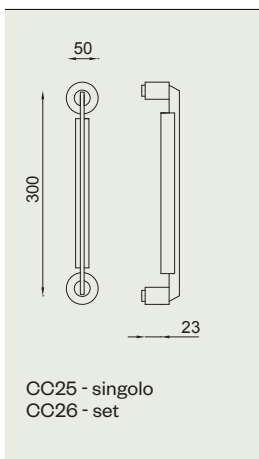

372-

dnd22-23

# C-1918 zancato

design:  
**Achille Castiglioni**  
**Gianfranco Cavaglia**

Acciaio inox AISI 316 + rame  
*AISI Stainless steel 316 + copper*

made in italy



## **S316 + R**

AISI 316 satinato  
+ inserto rame PVD  
*AISI 316 satin*  
*+ PVD copper insert*



## **L316 + R**

AISI 316 lucido  
+ inserto rame PVD  
*AISI 316 polished*  
*+ PVD copper insert*



## **S316 + N**

AISI 316 satinato  
+ inserto rame nero  
*AISI 316 satin*  
*+ black copper insert*



## **L316 + N**

AISI 316 lucido  
+ inserto rame nero  
*AISI 316 polished*  
*+ black copper insert*

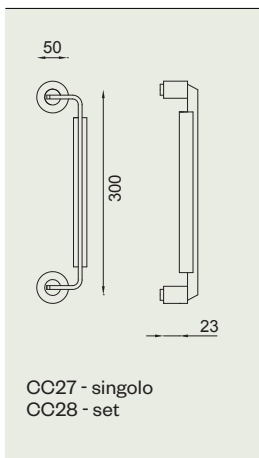

# logo

Ottone stampato a caldo  
*Hot stamped brass*

design:  
**Mauro Ronchi**

made in italy



**OC**

Power cromo lucido  
*Power polished chrome*



**PCS**

Power cromo satinato  
*Power satin chrome*



**ONS**

Nickel satinato  
*Satin nickel*



**PVX | forte®**

Inox satinato  
*Satin steel*

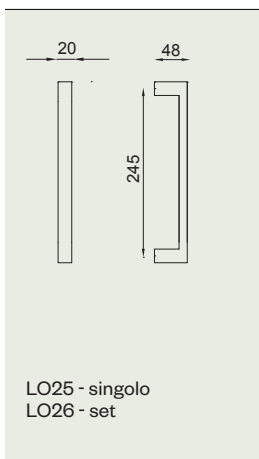

374-

dnd22-23



# logo B

Ottone stampato a caldo  
*Hot stamped brass*

**design:**  
**Mauro Ronchi**

made in italy



**CCS**

Cromo - Power cromo satinato  
*Chrome - Power satin chrome*

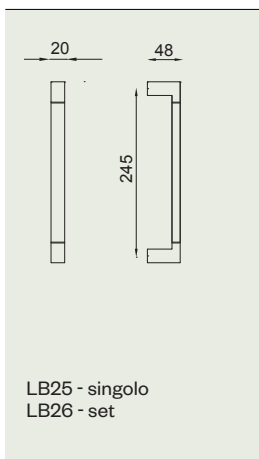

# linear

Ottone stampato a caldo  
*Hot stamped brass*

design:  
**Mauro Ronchi**

made in italy



**OGH**  
Bronzo satinato opaco  
*Matt satin bronze*



**OC**  
Power cromo lucido  
*Power polished chrome*



**PCS**  
Power cromo satinato  
*Power satin chrome*



**PVD-BG | forte®**  
Oro antico lucido  
*Antique bright gold*



**PVD-SG | forte®**  
Oro antico satinato  
*Antique satin gold*

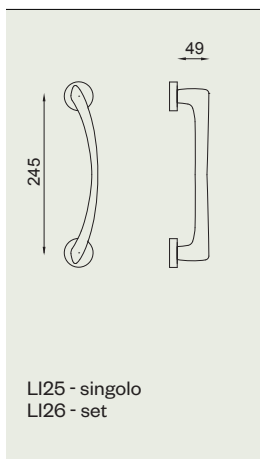

376-

dnd22-23

# linear

Ottone stampato a caldo  
*Hot stamped brass*

design:  
**Mauro Ronchi**

made in italy



**OGH**

Bronzo satinato opaco  
*Matt satin bronze*



**OC**

Power cromo lucido  
*Power polished chrome*



**PCS**

Power cromo satinato  
*Power satin chrome*



**PVD-BG | forte®**

Oro antico lucido  
*Antique bright gold*



**PVD-SG | forte®**

Oro antico satinato  
*Antique satin gold*

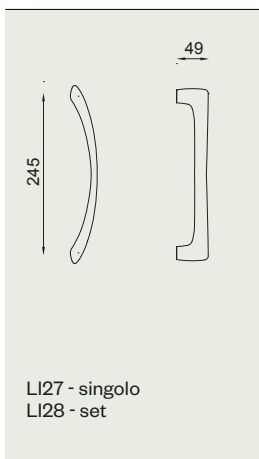

# project

Ottone stampato a caldo  
*Hot stamped brass*

**design: Dnd**  
**technical division**

made in italy

-  **AB**  
Bronzato  
*Antique bronze*
-  **OC**  
Power cromo lucido  
*Power polished chrome*
-  **PCS**  
Power cromo satinato  
*Power satin chrome*
-  **ONS**  
Nickel satinato  
*Satin nickel*
-  **ONO**  
Nero  
*Black*

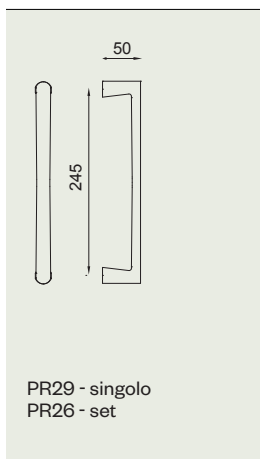

378-

dnd22-23

# project spostato

design: Dnd  
technical division

Ottone stampato a caldo  
*Hot stamped brass*

made in italy

-  **AB**  
Bronzato  
*Antique bronze*
-  **OC**  
Power cromo lucido  
*Power polished chrome*
-  **PCS**  
Power cromo satinato  
*Power satin chrome*
-  **ONS**  
Nickel satinato  
*Satin nickel*
-  **ONO**  
Nero  
*Black*

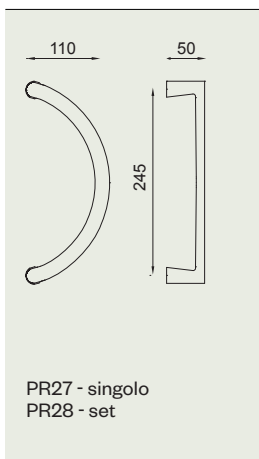

# art

Ottone stampato a caldo  
*Hot stamped brass*

design:  
**Mauro Ronchi**

made in italy



**OGH**

Bronzo satinato opaco  
*Matt satin bronze*



**OC**

Power cromo lucido  
*Power polished chrome*



**PCS**

Power cromo satinato  
*Power satin chrome*

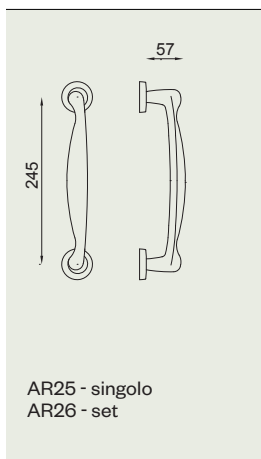

380-

dnd22-23

# go

Ottone stampato a caldo  
*Hot stamped brass*

design:  
**Mauro Ronchi**

made in italy



**OC**  
Power cromo lucido  
*Power polished chrome*



**PCS**  
Power cromo satinato  
*Power satin chrome*

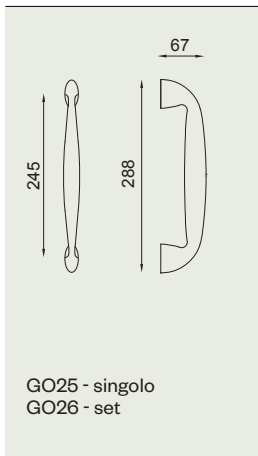

# intake

Ottone forgiato  
*Forged brass*

design:  
**Andrea Morgante**

made in italy



**OC**

Power cromo lucido  
*Power polished chrome*

**Altre finiture disponibili  
su richiesta.**

*Other finishes available on  
demand.*

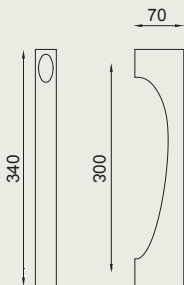

IN25 - singolo  
IN26 - set



382-

dnd22-23



# fluke

Ottone stampato a caldo  
*Hot stamped brass*

**design:**  
**Karim Rashid**

made in italy



**OC**  
Power cromo lucido  
*Power polished chrome*



**PCS**  
Power cromo satinato  
*Power satin chrome*

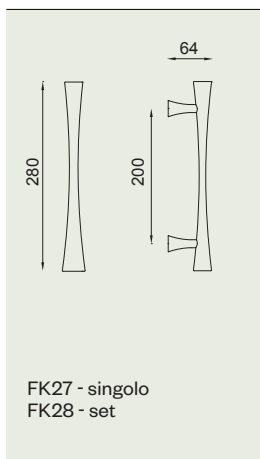

# domus

Ottone  
Brass

design: Dnd  
technical division

made in italy



**OLV**  
Lucido  
*Polished*



**OGH**  
Bronzo satinato opaco  
*Matt satin bronze*



**PCS**  
Power cromo satinato  
*Power satin chrome*

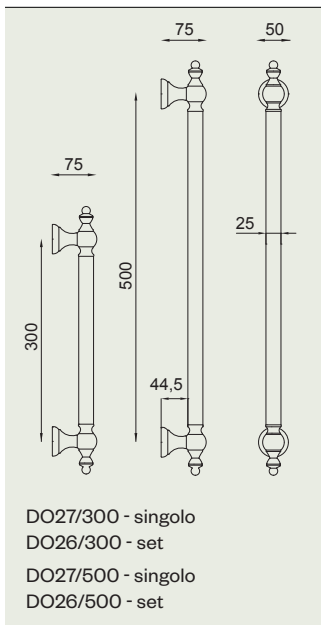



# cloe

Ottone forgiato  
*Forged brass*

**design: Dnd  
technical division**

made in italy

-  **OC**  
Power cromo lucido  
*Power polished chrome*
-  **PCS**  
Power cromo satinato  
*Power satin chrome*
-  **PGS | forte®**  
Grafite satinato  
*Satin graphite*

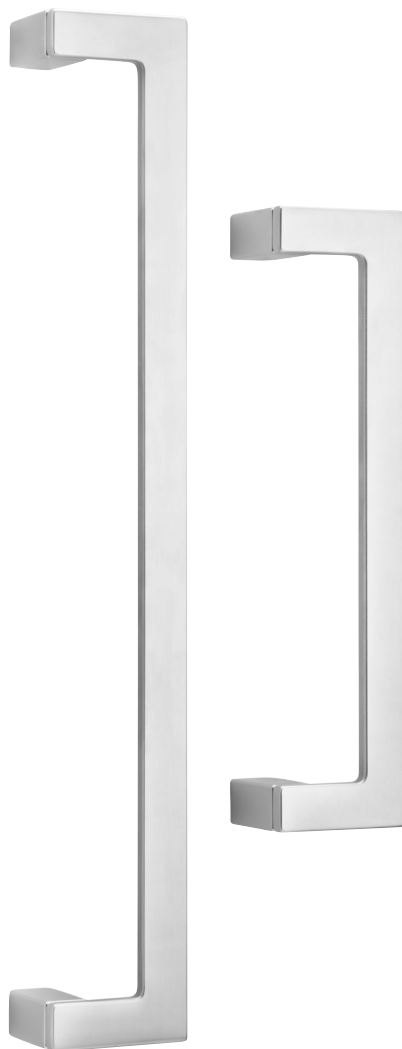
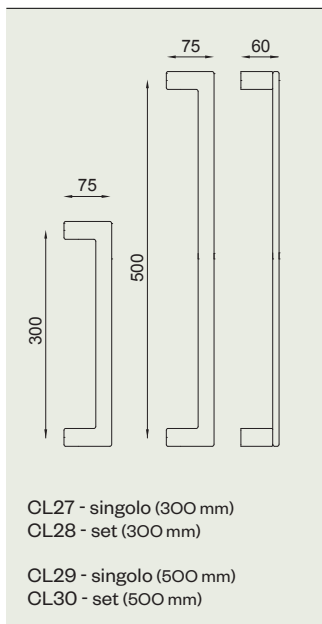

# tube round

design: Dnd  
technical division

Ottone  
Brass

made in italy

-  **PCS**  
Power cromo satinato  
*Power satin chrome*
-  **ONO**  
Nero  
*Black*
-  **PGS | forte® \***  
Grafite satinato  
*Satin graphite*
-  **PVD-SG | forte® \***  
Oro antico satinato  
*Antique satin gold*

**\* Finitura disponibile  
solo per art. TR400 e TR401**  
*Finish available only on  
art. TR400 and TR401*

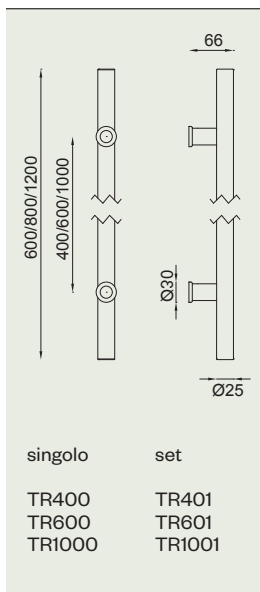

386-

dnd22-23

# solid square

design: Dnd  
technical division

Ottone forgiato  
*Forged brass*

made in italy



**OC**  
Power cromo lucido  
*Power polished chrome*



**PCS**  
Power cromo satinato  
*Power satin chrome*



**ONO**  
Nero  
*Black*



**PGS | forte®\***  
Grafite satinato  
*Satin graphite*

**\* Finitura disponibile  
solo per art. SQ400 e SQ401**  
*Finish available only on  
art. SQ400 and SQ401*

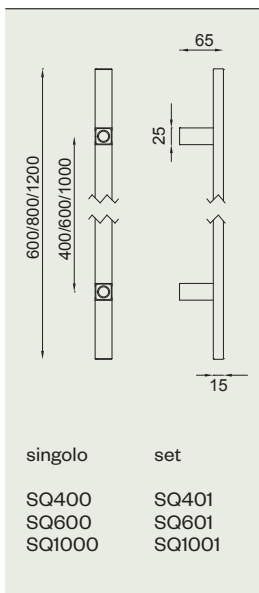

# only

Ottone  
*Solid brass*

**design: Dnd  
technical division**

made in italy



**OLV**  
Lucido  
*Polished*



**AF**  
Anticato  
*Antique finish*



**OGH**  
Bronzo satinato opaco  
*Matt satin bronze*



**OCS**  
Cromo satinato  
*Satin chrome*

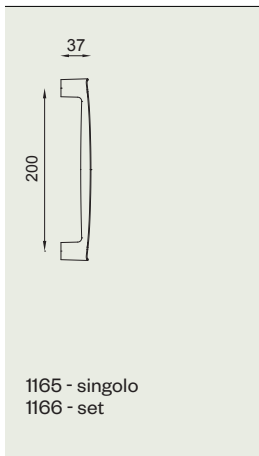

388-

**dnd**22-23

# luce

Zama  
Zamak

design: Dnd  
technical division

made in italy



**ZC**  
Cromo lucido  
*Polished chrome*



**ZCS**  
Cromo satinato  
*Satin chrome*



**ZNE**  
Nero  
*Black*

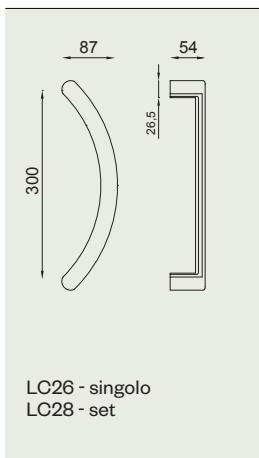

# beverly

Ottone stampato a caldo  
*Hot stamped brass*

**design: Dnd  
technical division**

made in italy



**OLV**  
Lucido  
*Polished*



**OGH**  
Bronzo satinato opaco  
*Matt satin bronze*

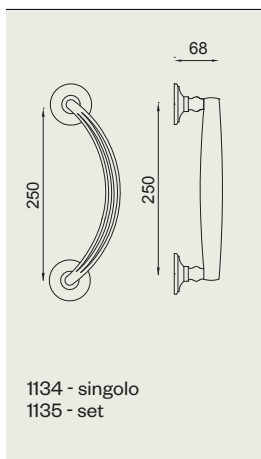

390-

dnd22-23



# beverly corto

design: Dnd  
technical division

Ottone stampato a caldo  
*Hot stamped brass*

made in italy



**OLV**  
Lucido  
*Polished*



**OGH**  
Bronzo satinato opaco  
*Matt satin bronze*

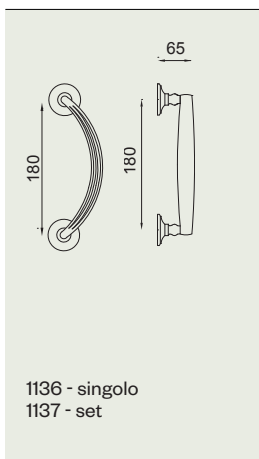

# daniela

Ottone  
Solid brass

design: Dnd  
technical division

made in italy

-  **OLV**  
Lucido  
*Polished*
-  **AB**  
Bronzato  
*Antique bronze*
-  **AF**  
Anticato  
*Antique finish*
-  **FAN**  
Ferro anticato  
*Antique iron*
-  **ONV**  
Nickel lucido  
*Polished nickel*

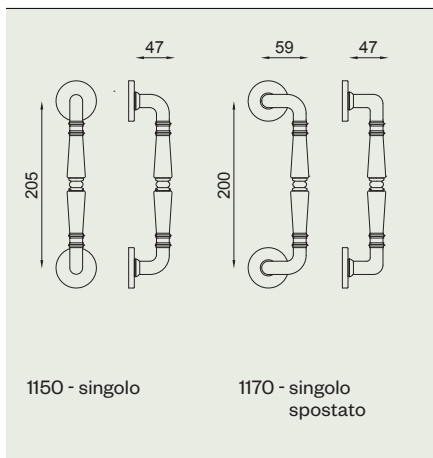

1150 - singolo

1170 - singolo  
spostato

392-

dnd22-23

# latina

Ottone stampato a caldo  
*Hot stamped brass*

design:  
**Mauro Ronchi**

made in italy



**OGH**

Bronzo satinato opaco  
*Matt satin bronze*



**BSS**

Bronzo scuro sfumato  
*Shaded dark bronze*



**PVD | forte®**

Ottone lucido  
*Polished brass*

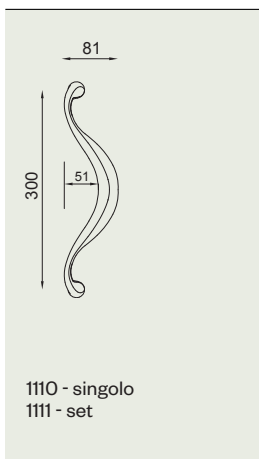

# maniglioni

- pull handles  
for lift

per alzante  
scorrevole

sliding  
system

# edra

Ottone stampato a caldo  
*Hot stamped brass*

design:  
**Mauro Ronchi**

made in italy

 **OGH**  
Bronzo satinato opaco  
*Matt satin bronze*

 **OC**  
Power cromo lucido  
*Power polished chrome*

 **PCS**  
Power cromo satinato  
*Power satin chrome*

 **ONO**  
Nero  
*Black*

 **ONS**  
Nickel satinato  
*Satin nickel*

 **PGS | forte®**  
Grafite satinato  
*Satin graphite*

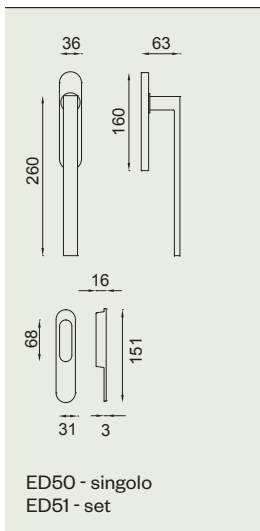

396-

dnd22-23

# edra corto

design:  
**Mauro Ronchi**

Ottone stampato a caldo  
*Hot stamped brass*

made in italy



**OC**  
Power cromo lucido  
*Power polished chrome*



**PCS**  
Power cromo satinato  
*Power satin chrome*

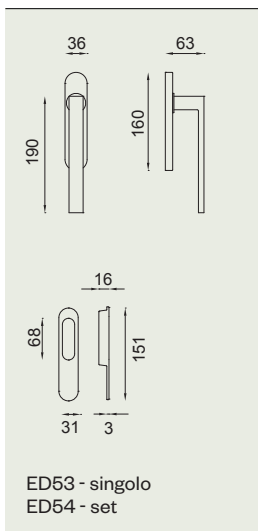

# edra 02

Ottone stampato a caldo  
*Hot stamped brass*

design:  
**Mauro Ronchi**

made in italy



**OGH**  
Bronzo satinato opaco  
*Matt satin bronze*



**OC**  
Power cromo lucido  
*Power polished chrome*



**PCS**  
Power cromo satinato  
*Power satin chrome*



**ONO**  
Nero  
*Black*



**ONS**  
Nickel satinato  
*Satin nickel*



**PGS | forte®**  
Grafite satinato  
*Satin graphite*

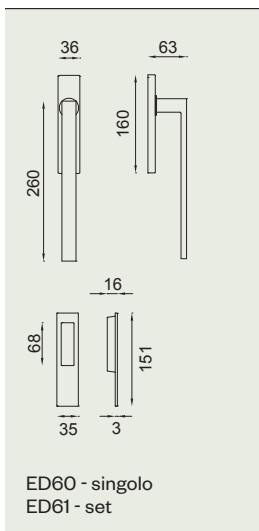

398-

dnd22-23



# edra 02 corto

design:  
**Mauro Ronchi**

Ottone stampato a caldo  
*Hot stamped brass*

made in italy



**OC**  
Power cromo lucido  
*Power polished chrome*



**PCS**  
Power cromo satinato  
*Power satin chrome*

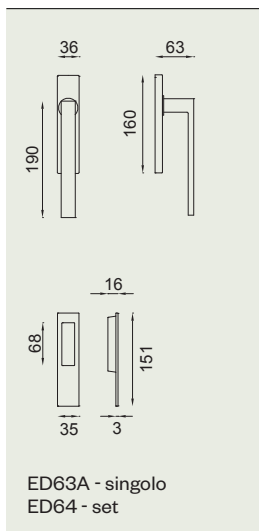

# luce

Zama  
Zamak

design: Dnd  
technical division

made in italy

 **ZGH**  
Bronzo satinato opaco  
*Matt satin bronze*

 **ZC**  
Cromo lucido  
*Polished chrome*

 **ZCS**  
Cromo satinato  
*Satin chrome*

 **ZNE**  
Nero  
*Black*

 **ZNS**  
Nickel satinato  
*Satin nickel*

 **ZAN**  
Antracite  
*Anthracite*

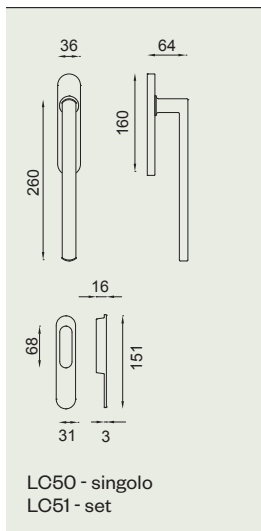

400-

dnd22-23

# luce 02

design: Dnd  
technical division

Zama  
Zamak

made in italy

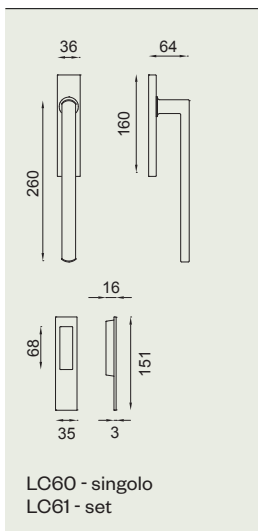
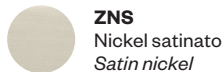

# slide

Ottone stampato a caldo  
*Hot stamped brass*

design:  
**Mauro Ronchi**

made in italy



**OLV**  
Lucido  
*Polished*



**OC**  
Power cromo lucido  
*Power polished chrome*



**PCS**  
Power cromo satinato  
*Power satin chrome*



**ONS**  
Nickel satinato  
*Satin nickel*

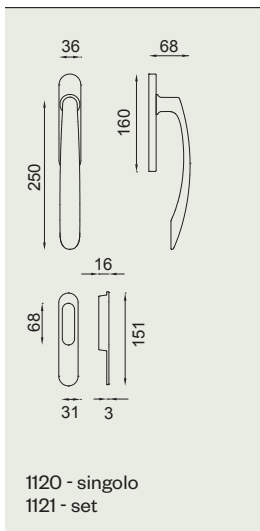

402-

dnd22-23

# slide corto

design:  
**Mauro Ronchi**

Ottone stampato a caldo  
*Hot stamped brass*

made in italy



**OLV**  
Lucido  
*Polished*



**OC**  
Power cromo lucido  
*Power polished chrome*



**PCS**  
Power cromo satinato  
*Power satin chrome*

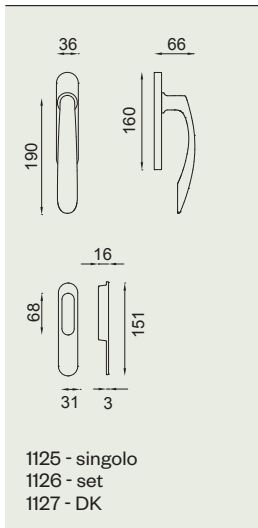

# liter

Ottone  
Brass

design: Dnd  
technical division

made in italy



**OLV**  
Lucido  
Polished



**OCS**  
Cromo satinato  
Satin chrome

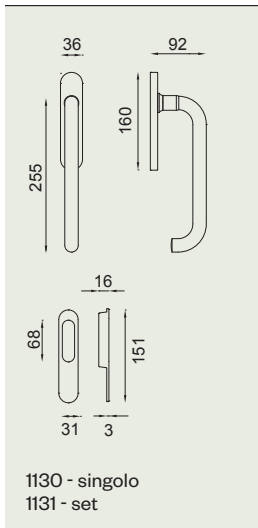

404-

dnd22-23

# placche incasso

Ottone stampato a caldo  
*Hot stamped brass*



**OLV**  
Lucido  
*Polished*



**OGH**  
Bronzo satinato opaco  
*Matt satin bronze*



**OC**  
Power cromo lucido  
*Power polished chrome*



**PCS**  
Power cromo satinato  
*Power satin chrome*



**ONS**  
Nickel satinato  
*Satin nickel*



**PGS | forte®**  
Grafite satinato  
*Satin graphite*



**TAN**  
Antracite  
*Anthracite*

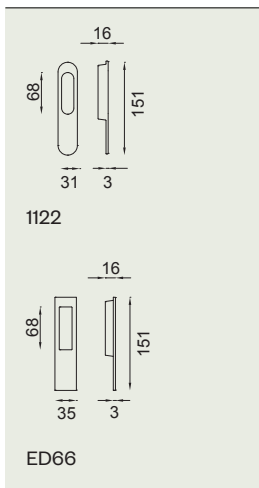

– knobs



pomoli

# lucrezia

Ottone forgiato  
Forged brass

design:  
Marco Pisati

made in italy

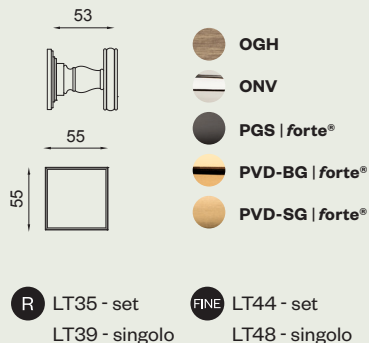

# lucrezia 02

Ottone forgiato  
Forged brass

design:  
Marco Pisati

made in italy

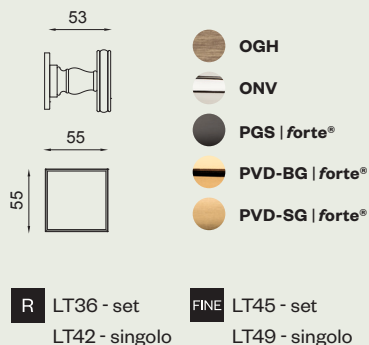

# lucrezia 03

Ottone forgiato  
*Forged brass*

design:  
**Marco Pisati**

made in italy

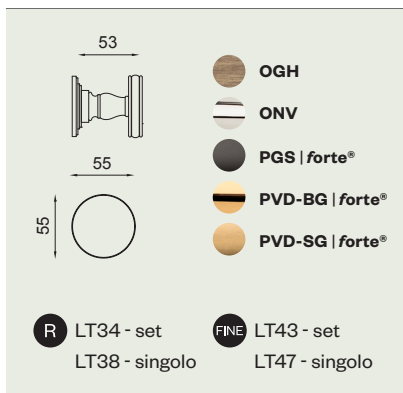

# ring

Ottone forgiato  
*Forged brass*

design: **Dnd**  
**technical division**

made in italy

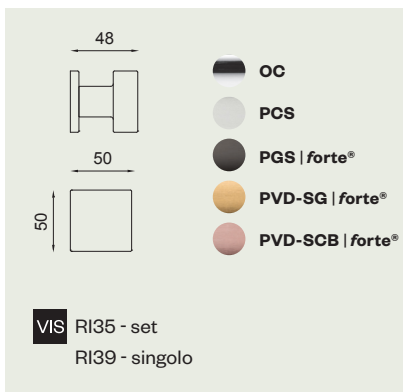

# rondò

Ottone forgiato  
Forged brass

design: Dnd  
technical division

made in italy

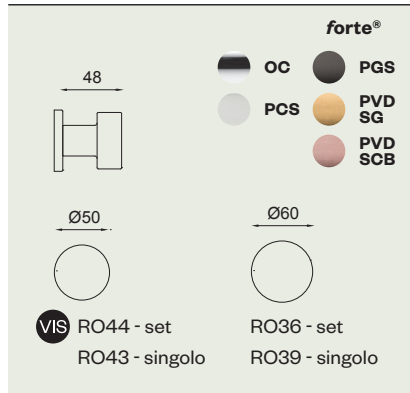

# easy

Ottone  
Solid brass

design: Dnd  
technical division

made in italy

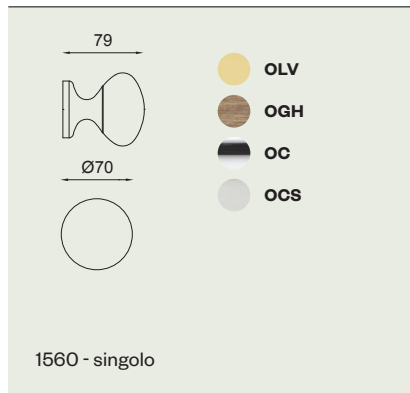

# timeless

Alluminio  
*Aluminium*



design:  
**Marco Pisati**

made in italy

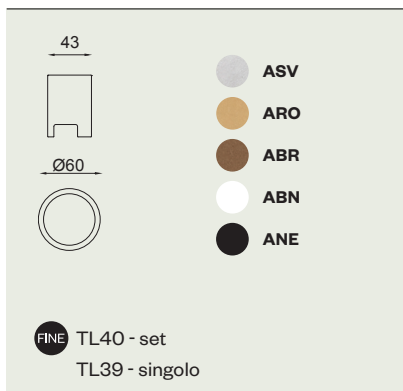

# project

Ottone  
*Solid brass*



design: **Dnd**  
**technical division**

made in italy

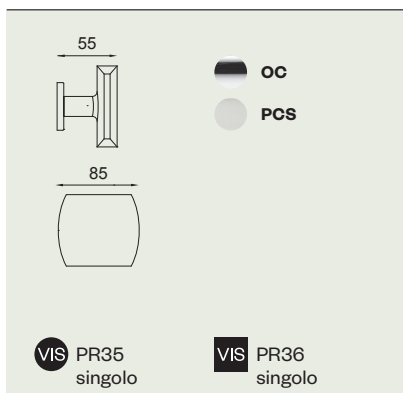

# quadro

Ottone  
*Solid brass*

design: Dnd  
technical division

made in italy

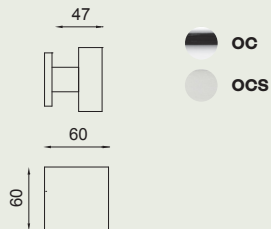

**VIS** 1575 - singolo

# sfera

Ottone  
*Solid brass*

design: Dnd  
technical division

made in italy



1570 - singolo

# fiorenza

Ottone stampato a caldo  
*Hot stamped brass*

design: Dnd  
technical division

made in italy

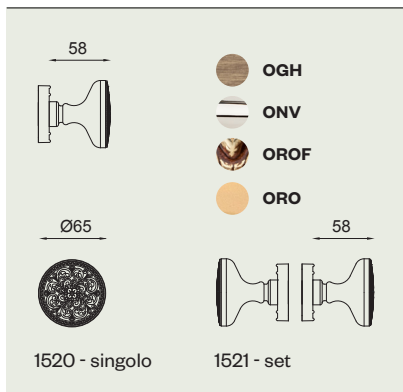

# ovale centrale

Ottone  
*Solid brass*

design: Dnd  
technical division

made in italy

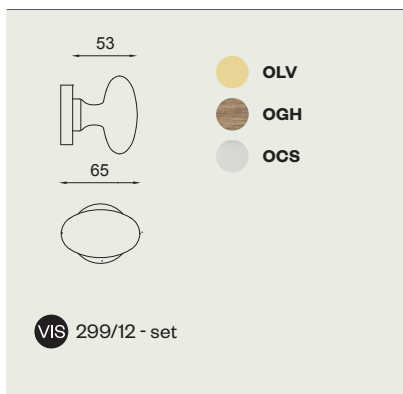

# pomolini per mobili *furniture knobs*



Alluminio  
*Aluminium*

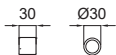

timeless

design: Marco Pisati

TL70  
mm. 30



ASV



ARO



ABR



ABN



ANE



Ottone  
*Solid brass*

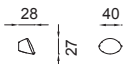

AR40  
ART



Ottone  
*Solid brass*

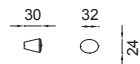

FL40  
FLUÒ



Ottone  
*Solid brass*



GO40  
GO



OLV



OC



PCS



# accessori per mobili lucrezia *lucrezia furniture accessories*

Ottone forgiato  
*Forged brass*

design:  
**Marco Pisati**

made in italy

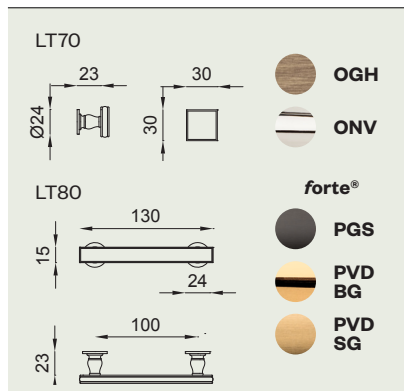

maniglie

– sliding  
door

per porte  
scorrevoli

handles

# ginkgo tonda

Ottone e zama  
Brass and zamak

design:  
Giulio Iacchetti

made in italy

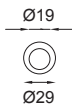
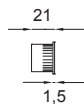

2191  
frontale per scorrevole  
*sliding door flush  
pull hole*

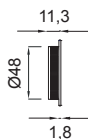

SD500  
rosetta incasso  
*sliding door handle*

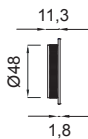

SD500P  
rosetta incasso  
foro chiave  
*sliding door handle  
key hole*



SD501  
set rosette incasso  
con frontale  
*sliding door handle set  
with flush pull hole*

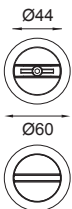

SD503  
set rosette incasso con  
nottolino q. 8 mm. con  
frontale  
*sliding door handle set  
with turn and release  
8 mm square  
spindle and flush  
pull hole*

# ginkgo tonda

design:  
Giulio Iacchetti

Ottone e zama  
Brass and zamak

made in italy



SD505

set rosette incasso foro chiave con  
frontale + serratura

*sliding door handle set key hole with  
flush pull hole + lock*

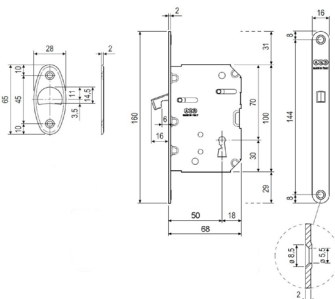
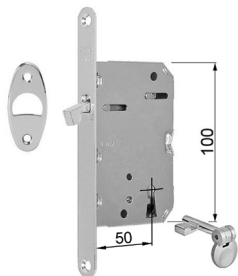

SE107



OC



OCS



ONO



SD506

set rosette incasso con nottolino q. 8 mm  
con frontale + serratura

*sliding door handle set with turn and  
release 8 mm square spindle with flush  
pull hole + lock*

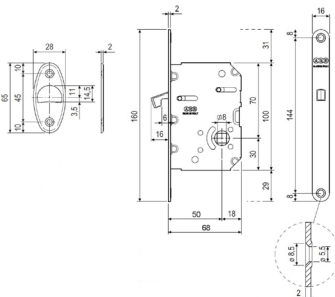
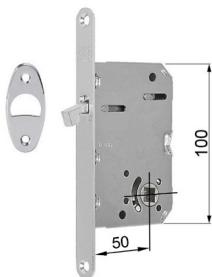

SE108

# ginkgo quadra

design:  
Giulio Iacchetti

Ottone e zama  
Brass and zamak

made in italy

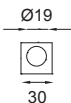

2189  
frontale per scorrevole  
*sliding door flush  
pull hole*

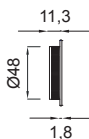

SD520  
rosetta incasso  
*sliding door handle*

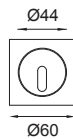
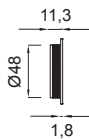

SD520P  
rosetta incasso  
foro chiave  
*sliding door handle  
key hole*



SD521  
set rosette incasso  
con frontale  
*sliding door handle set  
with flush pull hole*



SD523  
set rosette incasso con  
nottolino q.8 mm. con  
frontale  
*sliding door handle set  
with turn and release  
8 mm square  
spindle and flush  
pull hole*



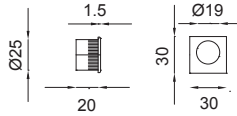

2189  
frontale per scorrevole  
*sliding door flush  
pull hole*

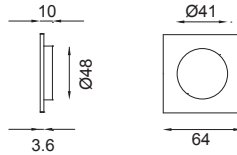

SD220  
rosetta incasso  
*sliding door handle*

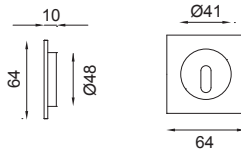

SD221  
rosetta incasso  
foro chiave  
*sliding door handle  
key hole*

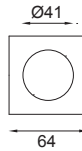

SD222  
set rosette incasso  
con frontale  
*sliding door handle set  
with flush pull hole*

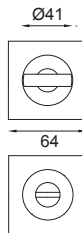

SD224  
set rosette incasso con  
nottolino q. 8 mm con  
frontale  
*sliding door handle set  
with turn and release  
8 mm square  
spindle and flush  
pull hole*



forte®















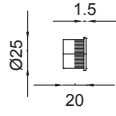

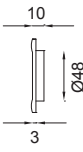
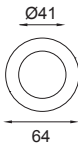

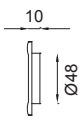

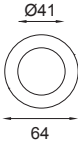

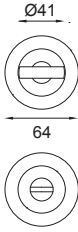





# rondò

Ottone  
Solid brass

design: Dnd  
technical division

made in italy

			2191 frontale per scorrevole <i>sliding door flush pull hole</i>
			SD200 rosetta incasso <i>sliding door handle</i>
			SD201 rosetta incasso foro chiave <i>sliding door handle key hole</i>
			SD202 set rosette incasso con frontale <i>sliding door handle set with flush pull hole</i>
			SD204 set rosette incasso con nottolino q. 8 mm con frontale <i>sliding door handle set with turn and release 8 mm square spindle and flush pull hole</i>

-  OLV
-  AB
-  OGH
-  OC
-  PCS
-  OBN
-  ONO
-  ONS
  
- forte®**
-  PVD  
BG
-  PVD  
SG
-  PVD  
SCB
-  PVD
-  PGS
-  PVX

# rondò

Ottone  
Solid brass

design: Dnd  
technical division

made in italy

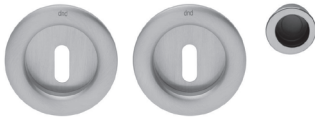

SD205

set rosette incasso foro chiave con  
frontale + serratura

*sliding door handle set key hole with  
flush pull hole + lock*

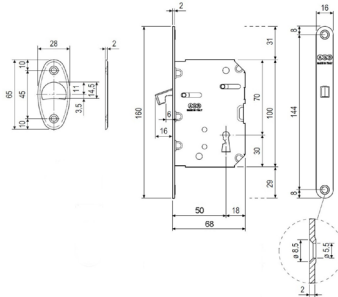
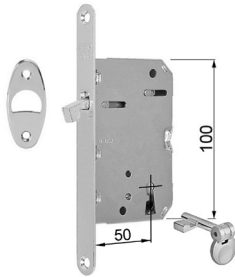

SE107



SD206

set rosette incasso con nottolino q.8 mm  
con frontale + serratura

*sliding door handle set with turn and  
release 8 mm square spindle with flush  
pull hole + lock*

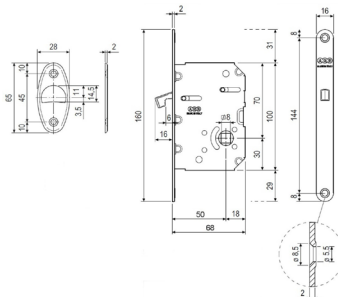
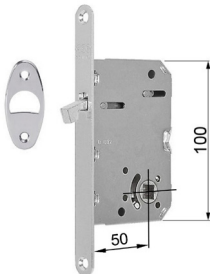

SE108

-  OLV
-  AB
-  OGH
-  OC
-  PCS
-  OBN
-  ONO
-  ONS

forte®





-  PVD  
BG
-  PVD  
SG
-  PVD  
SCB
-  PVD
-  PGS
-  PVX

# quadra

Ottone  
Solid brass

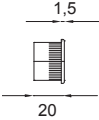
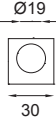
design: Dnd  
technical division

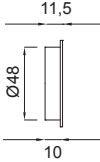
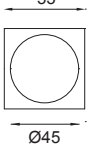
made in italy

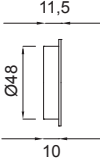
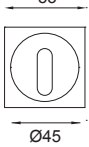
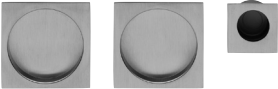
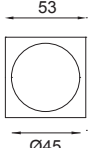
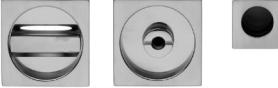
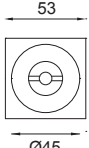
			<p>2189 frontale per scorrevole <i>sliding door flush pull hole</i></p>
			<p>2185 rosetta incasso <i>sliding door handle</i></p>
			<p>2185/F rosetta incasso foro chiave <i>sliding door handle key hole</i></p>
			<p>2185/S1 set rosette incasso con frontale <i>sliding door handle set with flush pull hole</i></p>
			<p>2186/S set rosette incasso con nottolino q. 8 mm con frontale <i>sliding door handle set with turn and release 8 mm square spindle and flush pull hole</i></p>



OC



OCS

# quadra

Ottone  
Solid brass

design: Dnd  
technical division

made in italy



2185/SE107

set rosette incasso foro chiave  
con frontale + serratura

*sliding door handle set key hole with  
flush pull hole + lock*

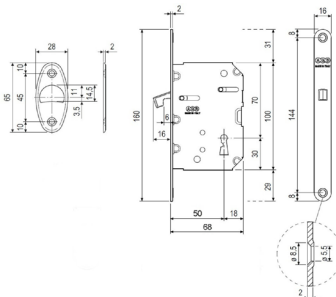
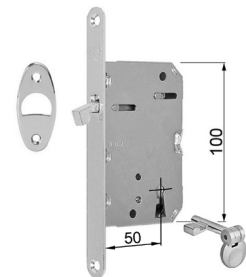

SE107



OC



OCS



2186/SE108

set rosette incasso con nottolino q.8 mm  
con frontale + serratura

*sliding door handle set with turn and  
release 8 mm square spindle with flush  
pull hole + lock*

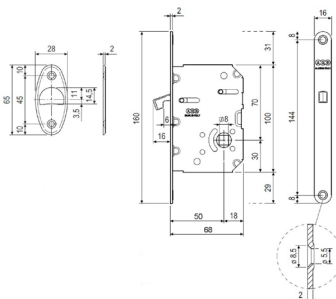
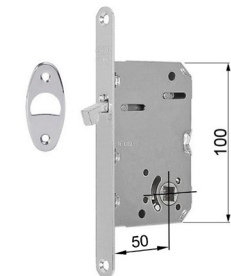











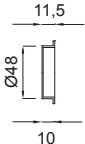
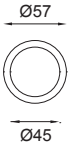

SE108

# tonda

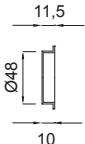
Ottone  
Solid brass

design: Dnd  
technical division

made in italy

			2191 frontale per scorrevole <i>sliding door flush pull hole</i>
			2193 rosetta incasso <i>sliding door handle</i>
			2193/F rosetta incasso foro chiave <i>sliding door handle key hole</i>
			2193/S1 set rosette incasso con frontale <i>sliding door handle set with flush pull hole</i>
			2194/S set rosette incasso con nottolino q. 8 mm con frontale <i>sliding door handle set with turn and release 8 mm square spindle and flush pull hole</i>





# rettangolare

design: Dnd  
technical division

Ottone  
Brass

made in italy

		<p><b>2187</b> placchetta incasso coprivate <i>sliding door handle concealed fixing</i></p> <p><b>2187/F</b> placchetta incasso coprivate con foro chiave <i>sliding door handle key hole concealed fixing</i></p>
		<p><b>2187/S1</b> set placchette incasso con frontale <i>sliding door handle set with flush pull hole</i></p>
		<p><b>2187/SE107</b> set placchette incasso foro chiave con frontale + serratura <i>sliding door handle set key hole with flush pull hole + lock</i></p>
		<p><b>2187/S</b> set placchette incasso con nottolino q. 8 mm e frontale <i>sliding door handle set with turn and release 8 mm square spindle and flush pull hole</i></p>
		<p><b>2187/SE108</b> set placchette incasso con nottolino q.8 mm con frontale e serratura <i>sliding door handle set with turn and release 8 mm sq. spindle with flush pull hole + lock</i></p>

-  **OC**
-  **OCS**
-  **ONO**



Ottone  
Brass

made in italy

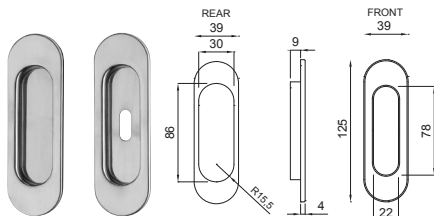

2197  
placchetta incasso coprivite  
*sliding door handle*  
*concealed fixing*

2197/F  
placchetta incasso coprivite  
con foro chiave  
*sliding door handle key hole*  
*concealed fixing*

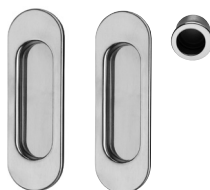

2197/S1  
set placchette incasso con  
frontale  
*sliding door handle set with*  
*flush pull hole*



2197/SE107  
set placchette incasso foro  
chiave con frontale  
+ serratura  
*sliding door handle set*  
*key hole with flush pull hole*  
*+ lock*



2197/S  
set placchette incasso con  
nottolino q. 8 mm e frontale  
*sliding door handle set with*  
*turn and release 8 mm square*  
*spindle and flush pull hole*



2197/SE108  
set placchette incasso con  
nottolino q. 8 mm con frontale  
e serratura  
*sliding door handle set with*  
*turn and release 8 mm sq.*  
*spindle with flush pull hole*  
*+ lock*



OLV



OGH



OC



OCS



ONO



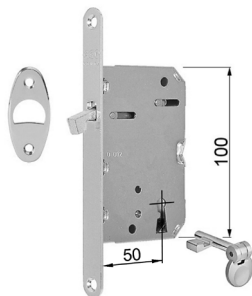

# serrature per porte scorrevoli

## locks for sliding door handles

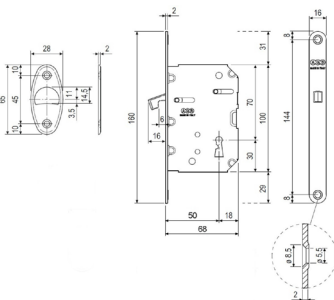

SE107  
serratura con chiave snodata  
lock with jointed key



-  **OLV**
-  **OGH**
-  **ONO**
-  **OBN**
-  **OCS**

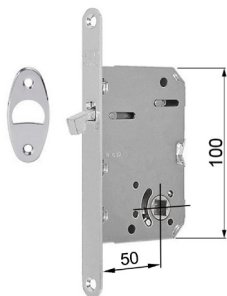

SE108  
serratura con foro quadro 8mm  
lock with 8 mm square hole

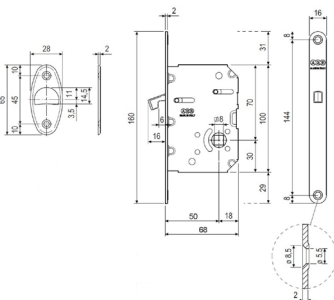



# articoli

—

vari

other  
complements

# nottolino dnd *dnd turn & release*

**design:**  
**Mauro Ronchi**

ottone  
*solid brass*

**finiture / finishes:**  
OLV OS AB OGH OC  
PCS ONV ONS  
**forte®**  
PVD PVX PGS  
PVD-BG PVD-SG

made in italy

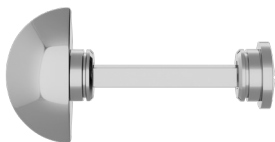

**NODN1**  
nottolino Dnd  
*Dnd turn & release*



**VIS** **RDN08+A**  
set nottolino su rosetta  
*turn & release set on rose*  
**50x7mm - VIS**

**52** **RDN03+A**  
set nottolino su rosetta  
*turn & release set on rose*  
**52x10mm - 52**



**FINE** **RDN44+A**  
set nottolino su rosetta  
*turn & release set on rose*  
**50x4mm - FINE**

**FINE** **RDN45+A**  
set nottolino su rosetta quadra  
*turn & release set on square rose*  
**50x4mm - FINE**



**VIS**

**RDN09+A**

set nottolino su rosetta quadra  
*turn & release set on square rose*  
**50x7mm - VIS**

**52**

**RDN05+A**

set nottolino su rosetta quadra  
smussata / *turn & release set on*  
*chamfered square rose*  
**52x10mm - 52**



**R**

**RDN18+A**

set nottolino su rosetta  
*turn & release set on rose*  
**45x50mm - ARDEA**

**R**

**RDN19+A**

set nottolino su rosetta  
*turn & release set on rose*  
**50x60mm - CASSIA**

# nottolino short *short turn & release*

**design:**  
**Dnd technical division**

ottone  
*solid brass*

**finiture / finishes:**  
OLV OS AB OGH OC  
PCS ONV ONS

**forte®**  
PVD PVX PGS PVD-BG  
PVD-SG PVD-SCB

made in italy



## **NODN20**

nottolino Short  
*Short turn & release*

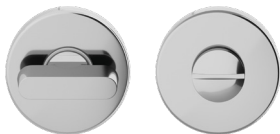

**VIS**

### **RDN25+A**

set nottolino su rosetta  
*turn & release set on rose*  
**50x7mm - VIS**

**52**

### **RDN27+A**

set nottolino su rosetta  
*turn & release set on rose*  
**52x10mm - 52**

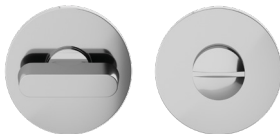

**FINE**

### **RDN20+A**

set nottolino su rosetta  
*turn & release set on rose*  
**50x4mm - FINE**

**VIS**

### **RDN26+A**

set nottolino su rosetta quadra  
*turn & release set on square rose*  
**50x7mm - VIS**





**52**

**RDN28+A**

set nottolino su rosetta quadra  
*turn & release set on square rose*  
**52x10mm - 52**

**FINE**

**RDN21+A**

set nottolino su rosetta quadra  
*turn & release set on square rose*  
**50x4mm - FINE**

# nottolino logo *logo turn & release*

**design:**  
**Mauro Ronchi**

ottone  
*solid brass*

**finiture / finishes:**  
OLV OS AB OGH OC  
PCS ONV ONS  
**forte®**  
PVD PVX PGS PVD-BG  
PVD-SG PVD-SCB

made in italy

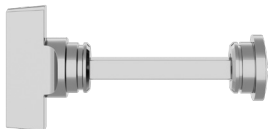

**NODN10**  
nottolino logo  
*logo turn & release*

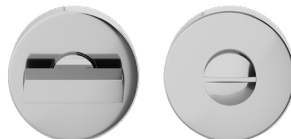
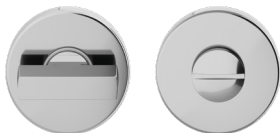

**VIS** **RDN12+A / RDN 12X+A (Inox)**  
set nottolino su rosetta  
*turn & release set on rose*  
**50x7mm - VIS**

**52** **RDN13+A**  
set nottolino su rosetta  
*turn & release set on rose*  
**52x10mm - 52**

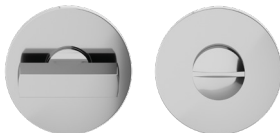

**FINE** **RDN40+A**  
set nottolino su rosetta  
*turn & release set on rose*  
**50x4mm - FINE**



**VIS**

**RDN14+A**

set nottolino su rosetta quadra  
*turn & release set on square rose*  
**50x7mm - VIS**

**52**

**RDN15+A**

set nottolino su rosetta quadra  
*turn & release set on square rose*  
**52x10mm - 52**



**FINE**

**RDN41+A**

set nottolino su rosetta quadra  
*turn & release set on square rose*  
**50x4mm - FINE**

# nottolino lucrezia

## lucrezia turn & release

design:  
**Marco Pisati**

ottone  
*solid brass*

finiture / finishes:  
OGH ONV  
forte®  
PGS PVD-BG PVD-SG

made in italy

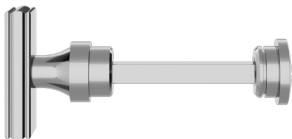

### NODN30

nottolino lucrezia  
*lucrezia turn & release*



**R** **RDN30+A**  
set nottolino su rosetta  
*turn & release set on rose*  
**53x8mm - LUCREZIA**

**FINE** **RDN31+A**  
set nottolino su rosetta  
*turn & release set on rose*  
**50x4mm - FINE**



**R** **RDN33+A**  
set nottolino su rosetta quadra  
*turn & release set on square rose*  
**53x8mm - LUCREZIA**

**FINE** **RDN32+A**  
set nottolino su rosetta quadra  
*turn & release set on square rose*  
**50x4mm - FINE**

# nottolino timeless

## *timeless turn & release*

**design:**  
**Marco Pisati**

Alluminio  
*Aluminium*

**finiture / finishes:**  
ASV ARO ABR ABN ANE  
ABT AGO AVP ABC

made in italy

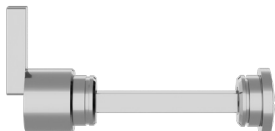

### **NODN50**

nottolino timeless  
*timeless turn & release*

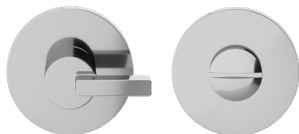

**FINE**

### **RDN50+A**

set nottolino su rosetta  
*turn & release set on rose*  
**50x4mm - FINE**

# nottolino (IN)finito (IN)finito turn & release

design:  
**Alfonso Femia**

ottone  
*solid brass*

finiture / finishes:  
OLV AB SO PCS ONO

made in italy



## **NODN66**

nottolino (IN)finito  
*(IN)finito turn & release*

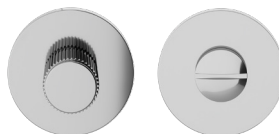

**R**

**RDN66+A**  
set nottolino su rosetta  
minimale (IN)finito  
*turn & release set on  
minimal (IN)finito rose*  
**25x50mm - (IN)finito**

**FINE**

**RDN75+A**  
set nottolino su rosetta  
*turn & release set on rose*  
**50x4mm - FINE**

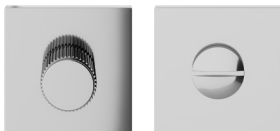

**FINE**

**RDN76+A**  
set nottolino su rosetta quadra  
*turn & release set on square rose*  
**50x4mm - FINE**

# nottolino DUE

## *DUE turn & release*

**design:**  
**Stefano Boeri**  
**Architetti**

ottone  
*solid brass*

**finiture / finishes:**  
PCS ONO  
forte® PGS PVD-SG

made in italy



**NODN65**  
nottolino DUE  
*DUE turn & release*

**FINE**

**RDN68+A**  
set nottolino su rosetta  
*turn & release set on rose*  
**50x4mm - FINE**



**R**

**RDN69+A**  
set nottolino su rosetta quadra  
*turn & release set on square rose*  
**45mm**

**FINE**

**RDN74+A**  
set nottolino su rosetta quadra  
*turn & release set on square rose*  
**45mm**



**R**

**RDN80+A**  
set nottolino su rosetta  
*turn & release set on rose*  
**53x8mm - LUCREZIA**

**FINE**

**RDN81+A**  
set nottolino su rosetta quadra  
*turn & release set on square rose*  
**53x8mm - LUCREZIA**

# nottolino tedesco

## tedesco turn & release

**design:**  
**Dnd technical division**

ottone  
*solid brass*

**finiture / finishes:**  
OLV OS AB OGC AF OGH  
OC OCS ONS FAN ONV

made in italy

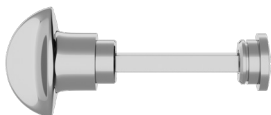

**2279**

nottolino tedesco  
*tedesco turn & release*

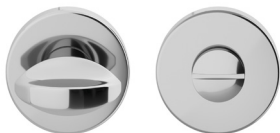

**VIS**

**2402+A**

set nottolino su rosetta  
*turn & release set on rose*  
**50x7mm - VIS**

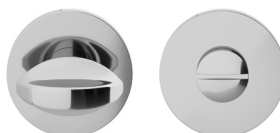

**FINE**

**2291+A**

set nottolino su rosetta  
*turn & release set on rose*  
**50x4mm - FINE**



**B**

**2286+A**

set nottolino su rosetta  
*turn & release set on rose*  
**50mm - B**



**V**

**2280+A**

set nottolino su rosetta  
*turn & release set on rose*  
**40x60mm - V**





**R** **2315+A**  
set nottolino su rosetta  
*turn & release set on rose*  
**55mm - FIRENZA**



**R** **2300+A**  
set nottolino su rosetta  
*turn & release set on rose*  
**63x52mm - LATINA**

OLV  
OGH  
ORO  
OROF  
ONV

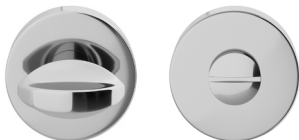

**52** **2452+A**  
set nottolino su rosetta  
*turn & release set on rose*  
**52x10mm - 52**

# nottolino blend

## *blend turn & release*

**design:**  
**Dnd technical division**

ottone  
*solid brass*

**finiture / finishes:**  
OLV OS AB OGC  
AF OC OCS ONS FAN ONV  
**forte®**  
PGS PVD-BG PVD-SG

made in italy



**2281**  
nottolino blend  
*blend turn & release*



**VIS** **2403+A**  
set nottolino su rosetta  
*turn & release set on rose*  
**50mm - VIS**

**VIS** **2405+A**  
set nottolino su rosetta quadra  
*turn & release set on square rose*  
**50mm - VIS**



**V** **2288+A**  
set nottolino su rosetta  
*turn & release set on rose*  
**40x60mm - V**

**B** **2284+A**  
set nottolino su rosetta  
*turn & release set on rose*  
**50mm - B**



FINE

**2406+A**

set nottolino su rosetta  
*turn & release set on rose*  
**50x4mm - FINE**

FINE

**2407+A**

set nottolino su rosetta quadra  
*turn & release set on square rose*  
**50x4mm - FINE**



R

**2408+A**

set nottolino su rosetta  
*turn & release set on rose*  
**53x8mm - LUCREZIA**

52

**2409+A**

set nottolino su rosetta  
*turn & release set on rose*  
**52x10mm - 52**



52

**2412+A**

set nottolino su rosetta quadra  
*turn & release set on square rose*  
**52x10mm - 52**

U

**2413+A**

set nottolino Blend  
su rosetta Unico  
*Blend turn & release  
set on Unico rose*  
**30x2mm - UNICO**

# nottolino joy

## joy turn & release

design:  
Dnd technical division

zama  
zamak

finiture / finishes:  
ZOS ZC ZGH ZCS  
ZNE ZBN ZNS ZAN

made in italy



### JYDN10

nottolino joy  
joy turn & release

### 2303+A

set nottolino su  
rosetta stretta R023  
turn & release set  
on R023 narrow rose  
30x60mm

### 2305+A

set nottolino su  
rosetta stretta R016  
turn & release set  
on R016 narrow rose  
30x60mm



VIS

### RDN22+A

set nottolino su rosetta  
turn & release set on rose  
50x7mm - VIS

VIS

### RDN24+A

set nottolino su rosetta quadra  
turn & release set on square rose  
50x7mm - VIS

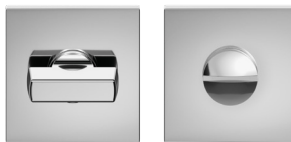
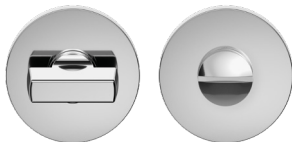

FINE

### RDN47+A

set nottolino su rosetta  
turn & release set on rose  
50x4mm - FINE

FINE

### RDN48+A

set nottolino su rosetta quadra  
turn & release set on square rose  
50x4mm - FINE

# nottolini su rosette strette *turn & releases on narrow roses*

**design:**  
**Dnd technical division**

ottone  
*solid brass*

**finiture / finishes:**  
OLV OS AB AF OGH  
OGC OC OCS PCS ONS  
FAN ONV OBN ONO

made in italy

**forte®**  
PVD PVX PGS



**RDN60+A**  
set nottolino dnd  
su rosetta stretta RO16  
*dnd turn & release set  
on RO16 narrow rose*  
**30x60mm**



**RDN61+A**  
set nottolino dnd  
su rosetta stretta dnd  
*dnd turn & release set  
on dnd narrow rose*  
**30x60mm**



**RDN62+A**  
set nottolino logo  
su rosetta stretta RO16  
*logo turn & release set  
on RO16 narrow rose*  
**30x60mm**



**RDN63+A**  
set nottolino logo  
su rosetta stretta dnd  
*logo turn & release set  
on RO16 narrow dnd rose*  
**30x60mm**



**2290+A**  
set nottolino tedesco  
su rosetta stretta RO16  
*tedesco turn & release  
set on RO16 narrow rose*  
**30x60mm**



**2301+A**  
set nottolino blend  
su rosetta stretta RO16  
*blend turn & release set  
on RO16 narrow rose*  
**30x60mm**



**2304+A**  
set nottolino blend  
su rosetta stretta RO23  
*blend turn & release set  
on RO23 narrow rose*  
**30x60mm**

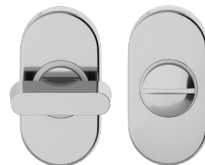

**RDN34+A**  
set nottolino short  
su rosetta stretta  
*short turn & release set  
on narrow rose*  
**30x60mm**



**RDN35+A**  
set nottolino short su  
rosetta stretta  
*short turn & release set  
on narrow rose*  
**30x60mm**

# bocchette tonde *round escutcheons*

**design:**  
**Dnd technical division**

ottone  
*solid brass*

**finiture / finishes:**  
OLV OS AB AF OGH OGC OC OCS  
PCS ONV ONS FAN OBN ONO ORO  
**forte**<sup>®</sup>  
PVD PVX PGS PVD-BG  
PVD-SG PVD-SCB

made in italy



**VIS** **BD12P / BD12Y**  
bocchetta  
*escutcheon*  
**50x7mm - VIS**

**45** **BD01P / BD01Y**  
bocchetta  
*escutcheon*  
**45x10mm - dnd**



**VIS** **BD12XP / BD12XY (Inox)**  
bocchetta  
*escutcheon*  
**50x7mm - VIS**

**52** **BD03P / BD03Y**  
bocchetta  
*escutcheon*  
**52x10mm - 52**



**FINE**

**BD40P / BD40Y**  
bocchetta 4mm  
*escutcheon 4mm*  
**50x4mm - FINE**



**B**

**BO20P / BO20Y**  
bocchetta bombata  
*rounded escutcheon*  
**50mm - B**



**VIS**

**BD35**  
bocchetta cieca  
*blind escutcheon*  
**50x7mm - VIS**



**VIS**

**BD36**  
bocchetta doppia mappa  
*escutcheon special key hole*  
**50x7mm - VIS**

# bocchette quadre *square escutcheons*

**design:**  
**Dnd technical division**

ottone  
*solid brass*

**finiture / finishes:**  
OLV OS AB OGH OC  
PCS ONS OBN ONO  
**forte®**  
PVD PVX PGS PVD-BG  
PVD-SG PVD-SCB

made in italy



**VIS**

**BD14P / BD14Y**  
bocchetta quadra  
*square escutcheon*  
**50x7mm - VIS**

**45**

**BD06P / BD06Y**  
bocchetta quadra  
*square escutcheon*  
**45mm**



**52**

**BD04P / BD04Y**  
bocchetta quadra  
*square escutcheon*  
**52x10mm - 52**

**52**

**BD05P / BD05Y**  
bocchetta quadra smussata  
*chamfered square escutcheon*  
**52x10mm - 52**





**FINE**

**BD41P / BD41Y**

bocchetta quadra 4 mm  
*square escutcheon 4 mm*  
**50x4mm - FINE**



**VIS**

**BD37**

bocchetta quadra cieca  
*blind square escutcheon*  
**50x7mm - VIS**

**VIS**

**BD38**

bocchetta quadra doppia  
mappa / *square escutcheon*  
*special key hole*  
**50x7mm - VIS**

# bocchette speciali *special escutcheons*

**design:**  
**Dnd technical division**

ottone  
*solid brass*

**finiture / finishes:**  
OLV OS AB OGC AF OC OCS PCS  
ONS FAN ONV OBN ONO  
**forte®**  
PVD PVX PGS PVD-BG  
PVD-SG PVD-SCB

made in italy

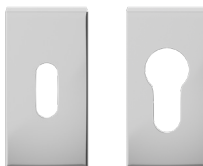
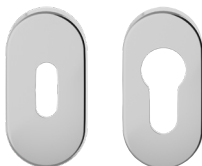

**S** **BO16P / BO16Y**  
bocchetta  
*escutcheon*  
**30x60mm**

**S** **BD61P / BD61Y**  
bocchetta rettangolare dnd  
*dnd rectangular escutcheon*  
**30x60mm**

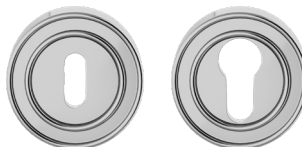

**S** **BO23P / BO23Y**  
bocchetta  
*escutcheon*  
**30x60mm**

**B** **BF10P / BF10Y** OGH  
bocchetta fiorenza ONV  
*fiorenza escutcheon* OROF  
**55mm** ORO

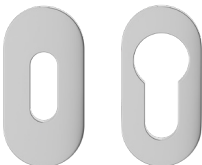

**NEW**

**U** **BD80P / BD80Y**  
bocchetta UNICO  
*UNICO escutcheon*  
**25x2mm**

# bocchette speciali *special escutcheons*

**design:**  
**Dnd technical division**

ottone  
*solid brass*

**finiture / finishes:**  
OLV OS AF AB OGC  
OGH BSS FAN ONV  
**forte®**  
PVD-BG PVD-SG PGS

made in italy

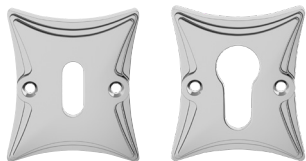

**R** **BD30P / BD30Y**  
bocchetta cassia  
*cassia escutcheon*  
**50x60mm**

**R** **BD31P / BD31Y**  
bocchetta ardea  
*ardea escutcheon*  
**45x50mm**



**R** **BO42P / BO42Y**  
bocchetta latina  
*latina escutcheon*  
**45x50mm**

**V** **BO14P / BO14Y**  
bocchetta ovale  
*oval escutcheon*  
**40x60mm**



**R** **BD32P / BD32Y**  
bocchetta lucrezia  
*lucrezia escutcheon*  
**53x8m - R**

**R** **BD33P / BD33Y**  
bocchetta lucrezia  
*lucrezia escutcheon*  
**53x8m - R**

# fermaporta door stop

**design:** ottone  
**Dnd technical division** solid brass

made in italy



**2268/1**  
fermaporta classic a parete  
*classic on wall door stop*  
**35x87**



**2268**  
fermaporta classic a  
pavimento / *classic on floor*  
*door stop*  
**42x96mm**

OLV  
OGH  
OC  
OCS  
ORO



**RI200**  
fermaporta ring  
*ring door stop*  
**30x30mm**

OLV ONS  
OGH ONO  
OC PGS  
PCS



**2265 leggero/light**  
**2265/P pesante/heavy**  
fermaporta cilindro  
*door stop*  
**29x45mm**

OLV  
OGH  
OC  
OCS  
ONS  
ONO



**2264**  
fermaporta chiocciola  
*door stop*  
**45mm**

OLV ONS  
OGH ONO  
OC  
OCS

# chiavi keys

ottone stampato a caldo  
*hot stamped brass*

## **finiture / finishes:**

OLV OS AB OC PCS ONS OBN ONO  
**forte**<sup>®</sup>  
PGS PVD-BG PVD-SG PVD-SCB



**DO1C**  
chiave dolce  
*dolce key*



**VI1C**  
chiave vita  
*vita key*

# cerniere – copricerniere *hinges – cover hinges*

ottone  
*solid brass*

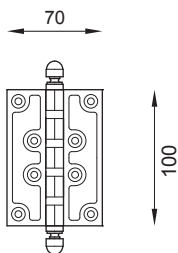

**2307**  
cerniera classic  
*classic hinge*

OLV  
OS  
AF  
AB  
OGC  
OGH  
FAN

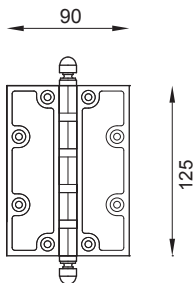

**2307/1**  
cerniera classic  
*classic hinge*

OLV  
OS  
AF  
AB  
OGC  
OGH  
FAN

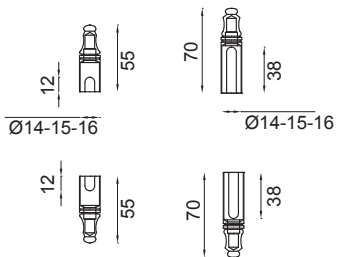

**2313**

set copricerniere corto con  
piramide / *short cover hinges  
set with pyramid*

**2313/2**

set copricerniere lungo con  
piramide asole lunghe / *long  
cover hinges set with pyramid  
long holes*

OLV  
OS  
AF  
AB  
OGC  
OGH  
FAN

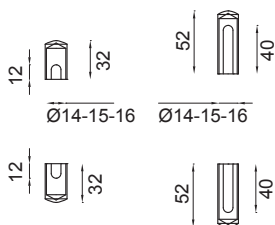

**2314**

set copricerniere corto piatto  
*flat short cover hinges set*

**2314/2**

set copricerniere lungo con  
asole lunghe e corte / *long  
cover hinges set with long or  
short holes*

OLV  
OC  
OCS  
ONS

# placche plates

ottone  
solid brass



**PL829** latina  
57x265mm



**PL570** classic  
46x252mm



**PL310** noxia  
40x251mm



**PL169** quadra  
42x245mm



**PLD01** dnd  
245mm



**PL279** sabina  
38x236mm



**PL390** daniela  
40x247mm





**PL580 cassia**  
**55X250mm**



**PL560 ardea**  
**48X252mm**



**PL520 fiorenza**  
**65X320mm**



**PL550 lucrezia**  
**53X300mm**



**PL400 slide**  
**35X160mm**



**PL283 sabina**  
**35X175mm**



**PL394 daniela**  
**37X170mm**



**PL401 slide q.**  
**35X160mm**

**note / notes**

A large grid of graph paper, consisting of 20 columns and 25 rows of small squares, occupies the majority of the page below the title.

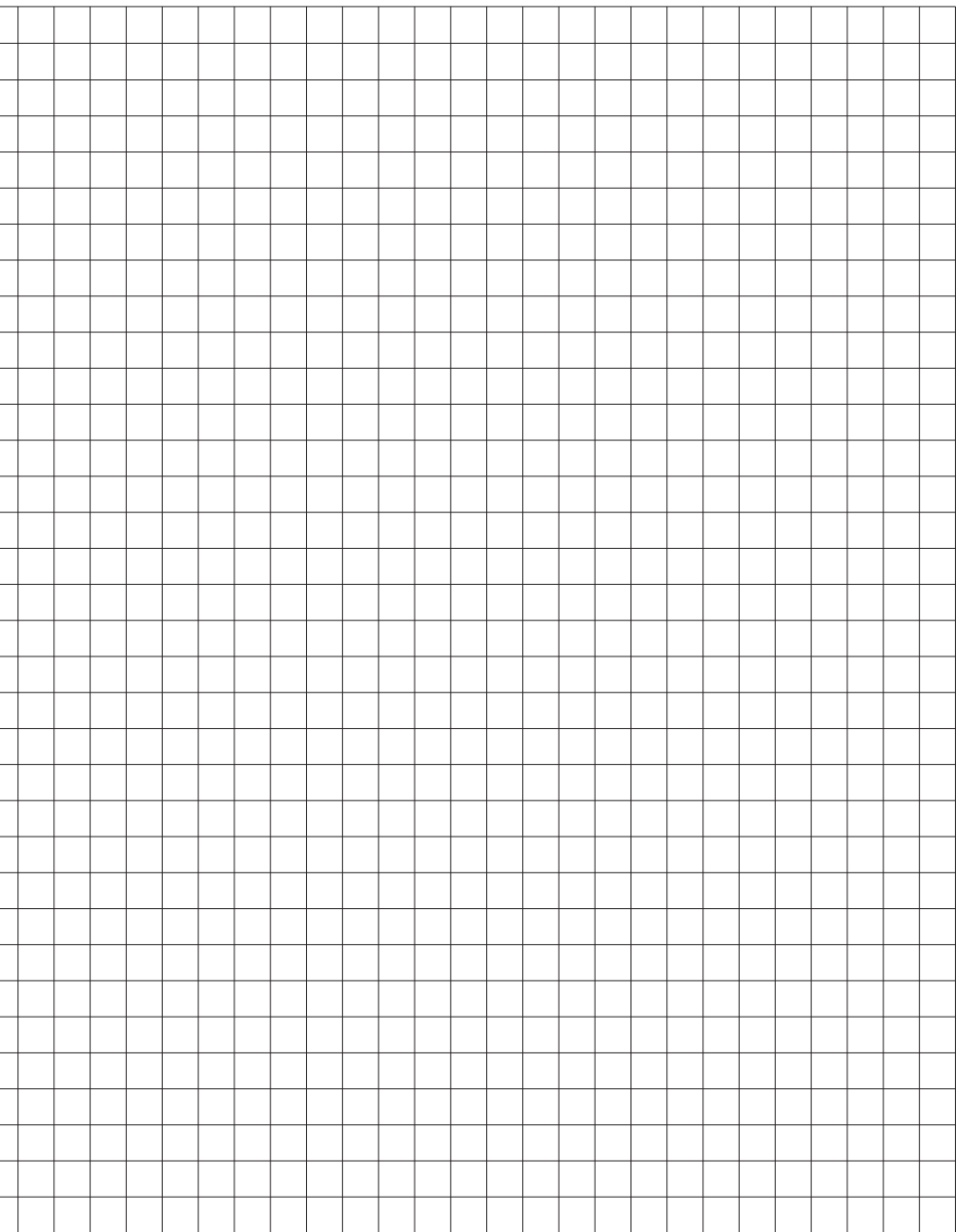

**note / notes**

A grid of graph paper for taking notes, consisting of 20 columns and 25 rows of small squares. The text "note / notes" is written in the top-left corner.

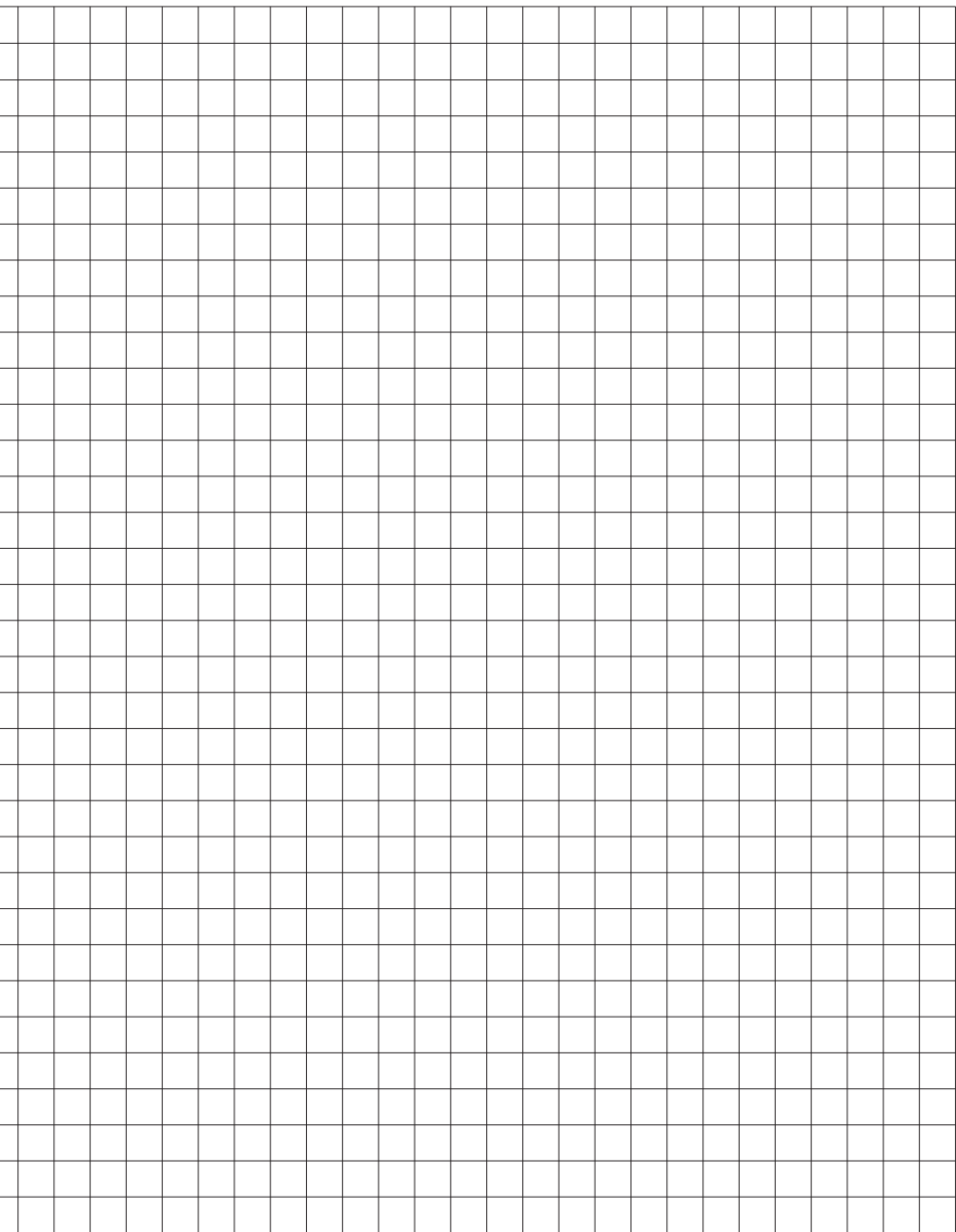

Copertina /

Cover

**Leonardo Sonnoli**

**Irene Bacchi**

**- Studio Sonnoli -**

Progetto grafico /

Graphic design

**Lorenzo De Bon**

**Marco Tonet**

**- Webkolm -**

Su progetto grafico originario /

On original graphic project

**- Studio Sonnoli -**

Fotografie /

Photographs

**Tiziano Reguzzi**

Stampa / Printing

**Tipolitografia Pagani**



**Dnd Martinelli S.r.l.**

Località Piani di Mura, 2  
25070 Casto (BS) - Italia

T +39 0365 899113

info@dndhandles.it

**www.dndhandles.it**



© 2022 Dnd Martinelli S.r.l.

Tutti i diritti riservati

*All rights reserved*

# dnd

handles  
with care

[dndhandles.it](https://dndhandles.it)  
made in italy

